

METRAHIT IM XTRA (M273A/D/W) & METRAHIT IM E-DRIVE (M274A/B) Insulation Tester, Milliohmmeter, TRMS Multimeter, Short-Circuited Coil Tester

3-447-035-03
6/10.19

Scope of Delivery (depending on instrument variant)

- 1 METRAHIT IM XTRA or METRAHIT IM E-DRIVE multimeter with rubber holster
- 1 Probe with start/stop and store/send function
- 1 KS17-2 cable set: 1 pair of safety measurement cables, red/black, with 4 mm test tips
- 1 Type KC4 Kelvin clip (1 pair with METRAHIT IM XTRA)
- 1 Type KC27 Kelvin probe (with METRAHIT IM E-DRIVE only)
- 1 Quick change, rechargeable lithium polymer battery with micro USB charging socket
- 1 USB mains power pack (5 V DC, 2 A) with cable and micro USB charging plug
- 1 DAkKS calibration certificate
- 1 Hard case for the multimeter and accessories
- 1 Condensed operating instructions, German/English
- Comprehensive operating instructions in German and English available on the Internet for download at www.gossenmetrawatt.com
- 1 Card with registration key for the software



Overview Supply

Accessories	Type	Article No.	M273S	M274S
METRAHIT IM XTRA		M273D	X	
METRAHIT IM E-DRIVE BT		M274B		X
Lilon module & USB charger	Z270A+		X	X
Mains module with electrical isolation and USB charger			0	0
Remote probe	Z270S	Z270S	X	X
Cable set		GTY362003		
	KS17-2	P0002	X	X
1 pair Kelvin clips	KC4	Z227A	X	0
1 pair Kelvin probes	KC27	Z227B	0	0
1 Kelvin clip & 1 Kelvin probe	KC&S	Z227C	—	X
Hard case	HC40	Z270K	X	X
COIL Adapter 10 µH ..., 50 mH	COIL Adapter 50mH	Z270F	0	0
COIL Adapter 10 µH ..., 500 mH	COIL Adapter XTRA	Z270M	0	0
IZYTRONIQ Business Starter Licence	S101S & Z956A	S101S & Z956A	X	X

Legend

X = Standard

O = Option

— = not possible, not provided for

Overview of Included Features

Function	METRAHIT IM XTRA (BT) METRAHIT IM E-DRIVE (BT)
V _{DC} (Ri = 9 MΩ)	✓
V _{AC} / Hz TRMS (Ri = 9 MΩ)	1kHz filter
V _{AC+DC} TRMS (Ri = 9 MΩ)	1kHz filter
V _{AC+DC} TRMS (Ri = 1 MΩ) R _{ISO} range (interference voltage)	✓
Hz (V _{AC})	... 300 kHz
V _{AC, AC+DC} bandwidth	100 kHz
A _{DC, AC, AC+DC} / Hz TRMS	10 nA ... 1 A
Fuse	1 A / 1000 V - 30 kA
Current sensor transformation ratio $\geq C$	1 mV : 1 • 10 • 100 • 1000 mA
Hz (A AC)	... 30 kHz
Insulation resistance RISO: test voltages	50 • 100 • 250 • 500 • 1000 V
Short-circuited coil test (1 kV) with COIL adapter	Option
Duty cycle measurement as %	✓
RPM measurement	✓
Resistance R _{lo} with 200 mA per EN 61557 / VDE 0413	✓
Milliohm with 4-wire method, mΩ with 200 mA	✓
Milliohm with 4-wire method, mΩ with 1 A pulse	✓
Fuse	FF 1A/1000 V – 30 kA
Resistance Ω	✓
Continuity	✓
Diode ... 5.1 V	✓
Temperature: °C/°F TC type K and Pt100/1000 ¹	✓
Capacitance	✓
Min-Max / data hold	✓
Test sequence	20 steps
64 MBit memory ²	✓
Bluetooth® interface	METRAHIT IM XTRA BT METRAHIT IM E-DRIVE BT
WiFi interface	Option
3.5" TFT color graphic display	✓
Probe with start/stop and send/store keys	✓
Quick-change battery with USB charging	✓
Mains module with electrical isolation and USB	Option
WPC quick change battery for inductive charging	Option
Protection	IP 52
Measuring category	1000 V CAT III, 600 V CAT IV

¹ With optional temperature sensors

² For 300,000 measured values, sampling rate adjustable from 0.1 seconds to 9 hours

Accessories (sensors, plug inserts, adapters, consumable materials)

The accessories available for your instrument are checked for compliance with currently valid safety regulations at regular intervals, and are amended as required for new applications. Currently up-to-date accessories which are suitable for your measuring instrument are listed on our website along with photo, order number, description and, depending upon the scope of the respective accessory, data sheet and operating instructions:

www.gossenmetrawatt.de

Software Version

These operating instructions describe a multimeter based on software version 1.2.6. Refer to chapter 4.4.1 in order to query the respectively installed version number.

Current operating instructions for the latest firmware update are available for download from our website at www.gossenmetrawatt.com.

Please register at myGMC in order to continuously receive the latest information regarding current software and firmware, as well as instrument updates and options.

Contents	Page	Contents	Page
1	Addresses	6.6.4	Direct and Pulsating Voltage Measurement, V DC and V (AC+DC) ..
1.1	Product Support	6.7	Resistance Measurement “Ω”
1.2	Recalibration Service	6.8	Capacitance Measurement F
1.3	Repair and Replacement Parts Service Calibration Center* and Rental Instrument Service	6.9	Temperature Measurement with Resistance Thermometer – Temp RTD
2	Safety Features and Precautions	6.10	Temperature Measurement with Thermocouple – Temp TC ..
2.1	Use for Intended Purpose	6.11	Continuity Test
2.2	Meanings of Danger Symbols	6.12	Diode Testing with Constant Current of 1 mA
2.3	Meanings of Acoustic Warning Signals	6.13	Milliohm Measurement – Rio (2-wire measurement)
3	Operating Overview	6.14	Milliohm Measurement – mΩ/4 (4-wire measurement)
3.1	Connections, Keys, Rotary Switch, Symbols	6.14.1	Compensation of Cable Resistance
3.2	Symbols Used in the Digital Display	6.14.2	Thermovoltage Compensation
3.3	Symbols Used for Rotary Switch Positions	6.14.3	Milliohm Measurement with 200 mA or 20 mA DC [mΩ]
3.4	User Interface Symbols in the Following Sections	6.14.4	Milliohm Measurement with 1 A Pulsating Measuring Current (automatic thermovoltage correction at 3 ... 300 mΩ)
3.5	Symbols on the Instrument	6.15	Current Measurement
4	Initial Startup	6.15.1	Direct and Pulsating Current Measurement, Direct Connection, – A DC and A (AC+DC)
4.1	Battery Pack	6.15.2	Alternating Current and Frequency Measurement, Direct Connection, – AAC and Hz
4.2	Mains Module	6.15.3	Direct and Pulsating Current Measurement with Current Clamp Sensor – ADC and A (AC+DC)
4.3	Switching the instrument On	6.15.4	Alternating Current Measurement with Current Clamp Sensor – AAC and Hz
4.4	Querying or Setting Operating Parameters – General Setup	6.16	Measuring Sequences
4.4.1	Info > Version – Check Current Software Version	7	Interface Operation
4.4.2	Language > German/English – Selecting the User Interface Language	7.1	Bluetooth Interface
4.4.3	System > Date/Time – Setting Date and Time	7.2	WiFi Interface
4.4.4	System > Brightness – Digital Display Brightness	8	Characteristic Values
4.4.5	System > Display Zeros	9	Maintenance and Calibration
4.4.6	System > Change Password	9.1	Displays – Error Messages
4.4.7	System > Display Profile – Digital Display View	9.2	Battery Pack
4.4.8	System > Default Settings	9.3	Fuse
4.5	Switching the Instrument Off	9.4	Housing Maintenance
4.5.1	System > Auto-OFF – Automatic Shutdown	9.5	Measurement Cables
5	Control Functions	9.6	Returns and Environmentally Sound Disposal
5.1	Help	9.7	Recalibration
5.2	Selecting Measuring Functions and Measuring Ranges	9.8	Manufacturer’s Guarantee
5.2.1	Automatic Range Selection	10	Accessories
5.2.2	Manual Range Selection	10.1	General
5.2.3	Quick Measurements	10.2	Technical Data for Measurement Cables (included with KS17-2 cable set and Z270S probe)
5.3	Zero Offset / Relative Measurements	11	Index
5.4	Display (TFT)		
5.4.1	Digital Display		
5.4.2	Analog Display		
5.5	Measured Value Storage – Data Function (auto-hold/compare)		
5.5.1	Saving Minimum and Maximum Values – “MinMax”		
5.6	Measured Value Memory – STORE Function.		
5.6.1	Remote read-out and storage via the Z270S probe		
5.6.2	Remote Read-Out and Storage via the PC – PUSH/PRINT Function		
5.7	Measurement Data Recording		
6	Measurements		
6.1	Enabling Parameter Changes		
6.2	Insulation Resistance Measurement – RISO Function		
6.2.1	Preparing for Measurement		
6.2.2	Performing Insulation Measurement		
6.2.3	Ending the Measurement and Discharging		
6.3	Short-Circuited Coil Measurement – COIL Function		
6.3.1	Preparing for Measurement		
6.3.2	Conducting the Short-Circuited Coil Measurement		
6.3.3	Ending the Measurement and Discharging		
6.4	Absorption Index Measurement – DAR		
6.5	Polarization Index Measurement – PI		
6.6	Voltage Measurement		
6.6.1	Alternating Voltage and Frequency Measurement V AC and Hz with Selectable Low-Pass Filter		
6.6.2	Duty Cycle Measurement – Duty AC		
6.6.3	RPM Measurement – RPM AC		

1 Addresses

1.1 Product Support

Technical Queries

(use, operation, software registration)

If required please contact:

GMC-I Messtechnik GmbH

Product Support Hotline

Phone : +49 911 8602-0

Fax: +49 911 8602-709

e-mail: support@gossenmetrawatt.com

1.2 Recalibration Service

We **calibrate** and **recalibrate** all instruments supplied by GMC-I Messtechnik GmbH, as well as other manufacturers, at our service center, for example after one year within the framework of your test equipment monitoring program, as well as prior to use etc. See also chapter 9.7.

1.3 Repair and Replacement Parts Service Calibration Center* and Rental Instrument Service

If required please contact:

GMC-I Service GmbH

Service Center

Beuthener Straße 41

90471 Nürnberg, Germany

Phone: +49-911-817718-0

Fax: +49-911-817718-253

e-mail: service@gossenmetrawatt.com

www.gmci-service.com

This address is only valid in Germany.

Please contact our respective representatives or subsidiaries for service in other countries.

* **DAkkS calibration laboratory for electrical quantities, registration no. D-K-15080-01-01, accredited per DIN EN ISO/IEC 17025**

Accredited quantities: direct voltage, direct current value, direct current resistance, alternating voltage, alternating current value, AC active power, AC apparent power, DC power, capacitance, frequency, temperature

Competent Partner

GMC-I Messtechnik GmbH is certified in accordance with DIN EN ISO 9001.

Our DAkkS calibration laboratory is accredited by the Deutsche Akkreditierungsstelle GmbH (national accreditation body of the Federal Republic of Germany) under registration number D-K-15080-01-01 in accordance with DIN EN ISO/IEC 17025.

We offer a complete range of expertise in the field of metrology: from **test reports** and **factory calibration certificates** right on up to **DAkkS calibration certificates**.

Our spectrum of offerings is rounded out with free **test equipment management**.

As a full service calibration laboratory, we can calibrate instruments from other manufacturers as well.

2 Safety Features and Precautions

You have selected an instrument which provides you with high levels of safety.

This instrument fulfills all requirements of applicable EU directives and national regulations. We confirm this with the CE mark. The relevant declaration of conformity can be obtained from GMC-I Messtechnik GmbH.

The TRMS digital multimeter has been manufactured and tested in accordance with the following safety regulations: IEC 61010-1:2010 / DIN EN 61010-1:2011 (VDE 0411-1:2011) and IEC 61010-2-033:2012 / DIN EN 61010-2-033 (VDE 0411-2-033)

When used for its intended purpose (see page 6), safety of the operator, as well as that of the instrument, is assured. Their safety is however not guaranteed, if the instrument is used improperly or handled carelessly.

In order to maintain flawless technical safety conditions, and to assure safe use, it's imperative that you read the operating instructions thoroughly and carefully before placing your instrument into service, and that you follow all instructions contained therein. Make sure that the operating instructions are available to all users of the instrument.

Tests may only be executed by a qualified electrician.

The multimeter is equipped with an automatic socket blocking mechanism for your safety, and in order to safeguard your instrument. This mechanism is linked to the rotary switch and only allows access to those jacks which are actually required for the selected function. It also prevents the user from turning the rotary switch to impermissible functions after the measurement cables have already been plugged in.

Measuring Categories and their Significance per IEC 61010-1

CAT	Definition
0	Measurements in electrical circuits which are not directly connected to the mains: <i>e.g. electrical systems in motor vehicles and aircraft, batteries etc.</i>
II	Measurements in electrical circuits which are electrically connected to the low-voltage mains: <i>via plug, e.g. in household, office and laboratory applications</i>
III	Measurements in building installations: stationary consumers, distributor terminals, devices connected permanently to the distributor
IV	Measurements at power sources for low-voltage installations: meters, mains terminals, primary overvoltage protection devices

The measuring category and the maximum rated voltage which are printed on the device apply to your measuring instrument, e.g. 1000 V CAT III.

Refer to chapter 10.2 regarding use of the measurement cables.

Observe the following safety precautions:

- The multimeter may not be used in **potentially explosive atmospheres**.
- The multimeter may only be operated by persons who are capable of recognizing **touch hazards** and taking the appropriate safety precautions. Touch hazards in accordance with the standard exist anywhere, where voltages of greater than 33 V (RMS) or 70 V DC may occur. Avoid working alone when taking measurements which involve touch hazards. Be certain that a second person is present.
- **Maximum allowable voltage** between the voltage measuring sockets or all connector sockets and ground is 1000 V for measuring category III and 600 V for measuring category IV.
- Be prepared for the occurrence of unexpected voltages at devices under test (e.g. defective devices). For example, capacitors may be dangerously charged.
- Make certain that the measurement cables are in flawless condition, e.g. no damage to insulation, no interruptions in cables or plugs etc.

- No measurements may be made with this instrument in electrical circuits with corona discharge (high-voltage).
- Special care is required when measurements are made in HF electrical circuits. Dangerous pulsating voltages may be present.
- Measurements under moist ambient conditions are not permitted.
- Be absolutely certain that the measuring ranges are not overloaded beyond their allowable capacities. Limit values are included in chapter 8, "Characteristic Values", in the table entitled "Measuring Functions and Measuring Ranges" in the "Overload Capacity" column.
- **The multimeter may only be operated with installed rechargeable batteries or mains module. Dangerous currents and voltages are otherwise not indicated, and the instrument may be damaged.**
- **Weak (insufficiently charged) rechargeable battery**
If the "weak battery" icon appears in the battery level indicator, it's no longer permissible to perform safety-relevant measurements. Furthermore, compliance with the listed specifications is no longer assured in the case of a weak rechargeable battery.
- The instrument may not be operated if the fuse cover, the rechargeable battery pack or the mains module has been removed, or if its housing is open.
- The input for the current measuring range is equipped with a fuse link.
Maximum permissible voltage for the measuring circuit (= rated voltage of the fuse) is 1000 V AC/DC.
Use specified fuses only (see page 49)! The fuse must have a **breaking capacity of at least 30 kA**.

Opening the Instrument / Repairs

The instrument may only be opened by authorized, trained personnel in order to ensure flawless operation and to assure that the guarantee is not rendered null and void.

Even original replacement parts may only be installed by authorized, trained personnel.

If it can be ascertained that the instrument has been opened by unauthorized personnel, no guarantee claims can be honored by the manufacturer with regard to personal safety, measuring accuracy, compliance with applicable safety measures or any consequential damages.

If a guarantee seal is included and it has been damaged or removed, all guarantee claims are rendered null and void.

Repair and Replacement of Parts by Authorized, Trained Personnel

When the instrument is opened, voltage conducting parts may be exposed. The instrument must be disconnected from the measuring circuit before performing repairs or replacing parts. If repair of a live, open instrument is required, it may only be carried out by trained personnel who are familiar with the dangers involved.

Defects and Extraordinary Strains

If it may be assumed that the instrument can no longer be operated safely, it must be removed from service and secured against unintentional use.

Safe operation can no longer be relied upon:

- If the device demonstrates visible damage
- If the instrument no longer functions, or if malfunctioning occurs
- After long periods of storage under unfavorable conditions (e.g. humidity, dust or extreme temperature (see "Ambient Conditions" on page 49))

2.1 Use for Intended Purpose

- The multimeter is a portable device which can be held in the hand during the performance of measurements.
- Only those types of measurements described in chapter 6 may be performed with the measuring instrument.
- The measuring instrument, including measurement cables and plug-on test probes, may only be utilized within the specified measuring category (see page 53 and the table on page 5 regarding significance).
- Overload limits may not be exceeded. See technical data on page 47 for overload values and overload limits.
- Measurements may only be performed under the specified ambient conditions. See page 49 regarding operating temperature range and relative humidity.
- The measuring instrument may only be used in accordance with the specified degree of protection (IP code) (see page 50).

Data Backup

We advise you to regularly transfer your stored data to a PC in order to prevent potential loss of data in the test instrument. We assume no responsibility for any data loss.

Battery Pack Safety Precautions

The test instrument is powered by a rechargeable lithium-ion battery. Consequently, it's absolutely essential to observe the following points:

- **Temperature ranges:** The test instrument with battery pack must not be exposed to direct **sunlight** or charged, operated or stored at **high temperatures**, for example in a car.
The following ambient conditions apply to the battery pack:
 - **Charging mode (10 ... 45 °C):** The battery may only be charged within this temperature range.
 - **Measuring mode (–10 ... 50 °C):** The battery may only be used within this temperature range.
 - **Storage (–20 ... 50 °C):** The maximum **storage temperature** is 50 °C.
- **Excessive depletion:** The rechargeable battery's safety circuit consumes minimal amounts of current. In order to prevent the battery from becoming fully depleted, the instrument should be connected to the mains for recharging at least once a year, and preferably at more frequent, regular intervals. In some cases it's no longer possible to recharge a fully depleted battery, in which case it must be replaced by GMC-I Service GmbH.



Attention!

Excessive depletion should be avoided because the battery's service life might otherwise be reduced, or the battery could fail. The battery pack is subject to self-discharging at a rate of roughly 25% per year.



Attention!

Battery pack transport:

Observe the supplementary sheet with safety information for the Z270A or Z270G battery pack with rechargeable lithium-polymer battery (3-349-997-15 oder 3-447-030-15)!

The supplementary sheet with safety information for the Z270A/Z270G battery pack is included with the manufacturer's safety data sheet for the installed lithium-polymer battery.

2.2 Meanings of Danger Symbols



Warning concerning a point of danger (attention, observe documentation!)



Warning concerning dangerous voltage at the measurement input: $U > 15 \text{ V AC}$ or $U > 25 \text{ V DC}$

2.3 Meanings of Acoustic Warning Signals

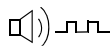

Hi-voltage warning: $> 1000 \text{ V}$ (intermittent acoustic signal)

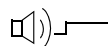

Heavy current warning: $> 1 \text{ A}$ (continuous acoustic signal)

3 Operating Overview

3.1 Connections, Keys, Rotary Switch, Symbols



- 1 Charging status LED (charging mode – yellow: battery is charging, green: fully charged)
- 2 Display (TFT), see Chapter 3.2 for meanings of symbols
- 3 Softkeys (menu -dependent keys for selecting switching functions and parameters, and for starting/ending measurements)
- 4 **STORE**: Save key or push/print function for **IZYTRONIQ**
- 5 **OK**: Key for acknowledgment and for restarting the instrument from the standby mode by pressing and holding
- 6 **Rotary switch** for measuring functions, (see page 8 for meanings of symbols)
- 7 DAKKS calibration seal
- 8 Connector sockets for current measurement with automatic blocking
 ⊥ earthing input
 A current measurement input
- 9 **S+/S-**: sense terminals for 4-wire measurements (mΩ /4)
- 10 Extended connection for Z270S probe
 (operating instructions 3-349-996-15)
- 11 Connector sockets for voltage measurement with automatic blocking
 ⊥ earthing input
 V, Ω, Temp, MΩ, \rightarrow , \leftarrow , COIL measurement input
- 12 **ESC**: *Operating mode menu*:
 Press key briefly: Exit the menu level – jump back to a higher level, exit parameters entry without saving
 Press and hold: The instrument is switched to the standby mode. Switch back on by pressing and holding the **OK** key.
- 13 **MENU**: Key for accessing the five main menus.
- 14 **Scroll keys**:
 △ Increase parameter values
Operating mode menu: Selection of individual menu items
 ▽ Decrease values
Operating mode menu: Selection of individual menu items
 ▷ Increase measuring range or move decimal point to right (**Man** function)
 ◁ Decrease measuring range or move decimal point to left (**Man** function)
- 15 Brightness sensor

3.2 Symbols Used in the Digital Display

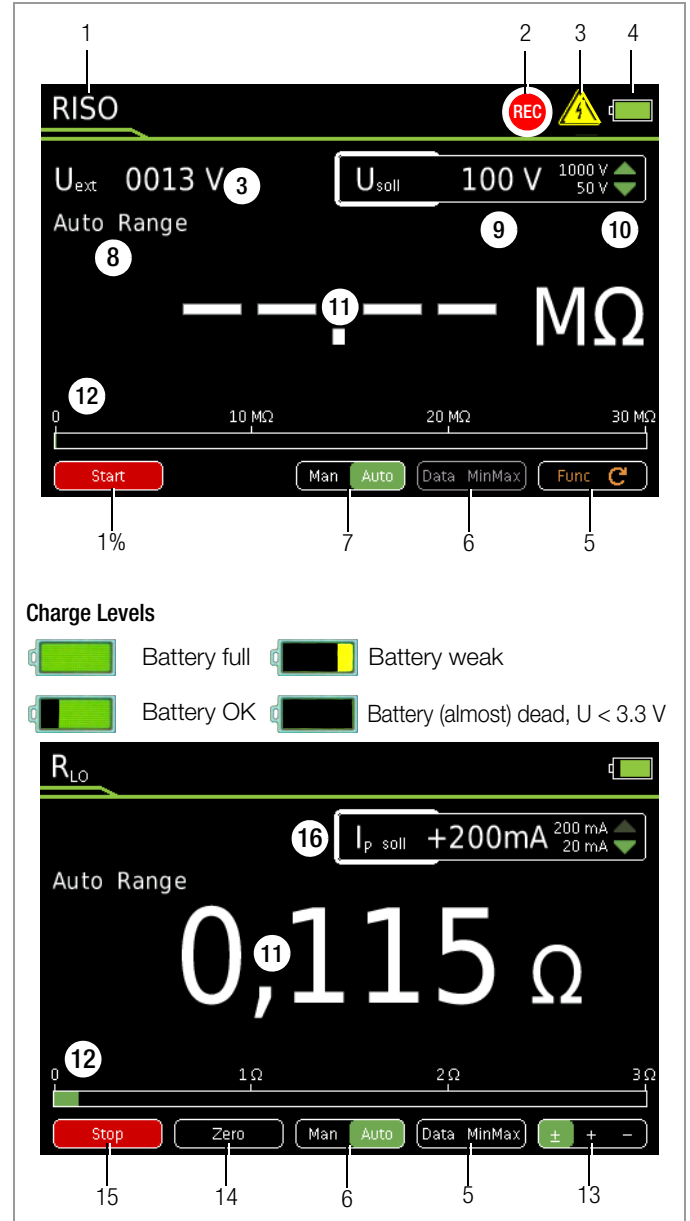

- 1 Momentary measuring function
- 2 Memory symbol
- 3 ⚠ Important, in this case: U_{ext} (interference voltage) or **warning regarding dangerous voltage: U > 15 V AC or U > 25 V DC**
- 4 Battery charge level
- 5 **Func**: switch back and forth amongst the functions of a given rotary switch position
- 6 **Data MinMax**: switch amongst "Data" (freeze measured value), "Min-Max storage" and deactivate both functions
- 7 **Man Auto**: switch back and forth between manual and automatic measuring range selection
- 8 Display of the selected measuring range with manual measuring range selection:
 ◁ Select a lower measuring range
 ▷ Select a higher measuring range
- 9 Selected test voltage
- 10 Select test voltage:
 △ Select a larger test voltage
 ▽ Select a smaller test voltage
- 11 Digital display with decimal point and polarity display
 Measuring range exceeded: **OL** is displayed
- 12 Scale for analog display
- 13 Polarity selection
- 14 **Zero**: Zero balancing active
- 15 **Start/Stop**: For measurements which are not started automatically
- 16 **I_p**: Test Current

3.3 Symbols Used for Rotary Switch Positions





Switches	FUNC	Display	Measuring Function	Additional Current Clamp Sensor Function ⇔ Clip = 1:1/10/100/1000 (via the "Setup for currently selected measurement" menu)
RISO	0/4	RISO MΩ	Insulation resistance measurement	
		Uext	Pulsating voltage, TRMS DC + AC, 15 Hz ... 500 Hz, only for detection of interference voltage! (before starting measurement)	
		Uset	Selectable test voltage: 50, 100, 250, 500 or 1000 V	
		UISO	Applied/measured test voltage during measurement	
Coil	1	Coil L1, L2, L3 [μs]	Short-circuited coil test with optional COIL adapter	
Coil	2	DAR [kΩ/s]	Dielectric absorption rate	
Coil	3	PI [kΩ/s]	>Polarization index	
V~	0/5	VAC	Alternating voltage, AC TRMS, full bandwidth	⊗ AC clamp (V): Current clamp sensor
Hz	1	Hz	Voltage frequency, full bandwidth	⊗ Hz client (V): Current clamp sensor
Hz	2	Duty AC %	Duty cycle measurement	
Hz	3	RPM AC	RPM measurement	
V~	4	V AC Fil	Alternating voltage, AC TRMS, with low-pass filter (1 kHz)	
V=	0/3	VDC ¹	Direct voltage	⊗ DC clamp (V): Current clamp sensor
V≈	1	V (AC+DC) ¹	Pulsating voltage, TRMS $V_{ACDC} = \sqrt{V_{AC}^2 + V_{DC}^2}$	⊗ AC + DC clamp (V): Current clamp sensor
V≈	2	V (AC+DC) Fil ¹	Pulsating voltage, TRMS AC DC, with low-pass filter (1 kHz)	
Ω	0/4	Ω	(DC) resistance	
— —	1	F— —, nF, μF	Capacitance	
Temp. RTD	2	°C Pt 100/1000	Temperature with Pt 100 / Pt 1000 resistance thermometer	
Temp. TC	3	°C, type K	Temperature, type K thermocouple	
⏏)	0/2	⏏) Ω	Continuity test with acoustic signal	
— — V	1	— — V	Diode voltage where I is constant	
Rlo	0	Rlo/2L Ω	2-wire milliohm measurement where I _P = ±±/- 200 mA	
mΩ/4	0	Rlo/4W Ω	4-wire milliohm measurement where I _P = 200 mA or 1 A	
A=	0/4	ADC	Direct current amperage	
A≈	1	A (AC+DC)	Pulsating current amperage, AC DC TRMS	
A~	2	AAC	Alternating current amperage, AC TRMS	
A~	3	Hz	Current frequency	

¹ Clip = off

3.4 User Interface Symbols in the Following Sections

- ▷ ... ▷ Scroll through main menu
- ▽ ... ▽ Scroll through submenu
- ◀ ▷ Select decimal point, increase/decrease measuring range
- △ ▽ Increase/decrease value (test voltage for insulation resistance measurement or threshold for continuity test)

3.5 Symbols on the Instrument

-  Warning concerning a point of danger (attention, observe documentation!)
-  Ground
- CAT III / IV** Measuring category III or IV device, see also "Measuring Categories and their Significance per IEC 61010-1" on page 5
-  Continuous, doubled or reinforced insulation
- CE** Indicates European Conformity
-  Fuse for current measuring ranges, see chapter 9.3
-  This device may not be disposed of with the trash. Further information regarding the WEEE mark can be accessed on the Internet at www.gossenmetrawatt.com under the search term WEEE (see also chapter 9.6).

Calibration seal (blue seal):

XY123	Consecutive number
D-K	Deutsche Akkreditierungsstelle GmbH – calibration lab
15080-01-01	Registration number
2019-04	Date of calibration (year – month)

See also "Recalibration" on page 53

4 Initial Startup

4.1 Battery Pack

Be certain to refer to Chapter 9.2 regarding correct installation of the battery pack!

Momentary battery capacity can be queried by clicking the **Info** item in the **General Setup** menu:

- Press the **MENU** key to this end.
- Then press the **General Setup** softkey.
- Select the **Info** parameter with the help of the $\Delta \nabla$ scroll keys. The “Battery” parameter indicates the battery pack’s charge level as a percentage.



Attention!

Disconnect the instrument from the measuring circuit before removing the battery pack for charging!

4.2 Mains Module

In preparation

4.3 Switching the instrument On

Switching the Instrument On Manually

- The instrument is switched on automatically after selecting any rotary switch position other than **OFF**.



Note

Electrical discharge and high frequency interference may cause incorrect displays to appear, and may disable the measuring sequence.

Disconnect the device from the measuring circuit. Switch the instrument off and back on again in order to reset. If the problem persists, briefly dislodge the battery from the connector contacts (see also chapter 9.2).

4.4 Querying or Setting Operating Parameters – General Setup

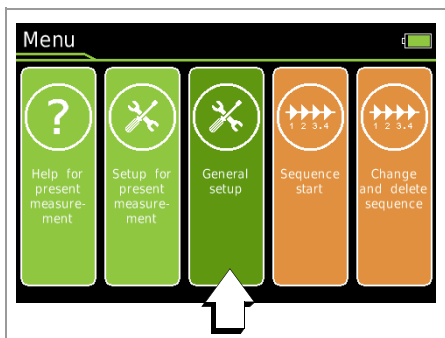

4.4.1 Info > Version – Check Current Software Version

- Press the **MENU** key.
- Press the **General Setup** softkey.
- Select the **Info** parameter with the help of the $\Delta \nabla$ scroll keys.
- The version parameter indicates the current software (firmware) revision level.
- The instrument is returned to the measuring mode after pressing the **ESC** key twice.

MENU > General Setup > $\Delta \nabla$ Info > Version

4.4.2 Language > German/English – Selecting the User Interface Language

- Press the **MENU** key.
- Press the **General Setup** softkey.
- Select the **Language** parameter with the help of the $\Delta \nabla$ scroll keys.
- Switch to the settings menu with the help of the \triangleright scroll key.
- Select the desired language with the $\Delta \nabla$ scroll keys.
- Acknowledge by pressing the **OK** key. The input cursor jumps back to the parameters list.
- Return to the main menu by pressing the **ESC** key or the **MENU** key.
- The instrument is returned to the measuring mode after pressing the **ESC** key once more.

MENU > General Setup > $\Delta \nabla$ Language \triangleright German/English

$\Delta \nabla$ **OK** **ESC** 2x

4.4.3 System > Date/Time – Setting Date and Time

- Press the **MENU** key.
- Press the **General Setup** softkey.
- Select the **System** parameter with the help of the $\Delta \nabla$ scroll keys.
- Switch to the submenu with the help of the \triangleright scroll key.
- Select the **Date** or **Time** parameter with the help of the $\Delta \nabla$ scroll keys.
- Acknowledge the selected parameter by pressing the **OK** key. The entry cursor jumps to a random position in the settings menu.
- Select the desired entry position with the $\triangleleft \triangleright$ scroll keys and change the respective value with the $\Delta \nabla$ scroll keys.
- Acknowledge the change with the **OK** key. The entry cursor once again marks the entire parameter line.
- Return to the main menu by pressing the **ESC** key twice or the **MENU** key once.
- The instrument is returned to the measuring mode after pressing the **ESC** key once more.

MENU > General Setup $\Delta \nabla$ System \triangleright $\Delta \nabla$ Time

OK 09:50:20 $\triangleleft \triangleright \Delta \nabla$ **OK** **ESC** 3x

MENU > General Setup $\Delta \nabla$ System \triangleright $\Delta \nabla$ Date

OK 13:06:2017 $\triangleleft \triangleright \Delta \nabla$ **OK**

ESC 3x

4.4.4 System > Brightness – Digital Display Brightness

Brightness of the digital display can be set between 1 (minimum brightness) and 9 (maximum brightness).

It can also be set to automatic. In this case, digital display brightness is adjusted depending on the intensity of the light which strikes the brightness sensor.

MENU > General Setup $\Delta \nabla$ System \triangleright $\Delta \nabla$ Brightness:

OK 1 ... 9, Auto $\Delta \nabla$ **OK** **ESC** 3x

4.4.5 System > Display Zeros

The **Display Zeros** parameter can be used to specify whether leading zeros will appear or be suppressed at the measured value display.

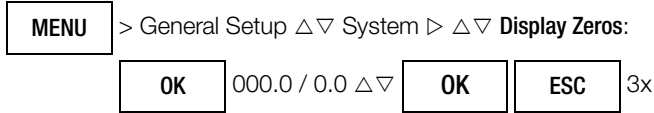

4.4.6 System > Change Password

A password must be entered in order to adjust the parameters for each of the following measurements:

- RISO: change test voltage
- $M\Omega/4$: change test current

The default password is "METRAHIT".

If necessary, an individual password can be assigned via the **Change Password** parameter.

Password protection is not activated with the default setting, i.e. "METRAHIT". An individual password must be entered in order to activate this function.

Password Characteristics

Maximum length 31 characters
 Composition: any desired alphanumeric characters

Keyboard for Entering Text

The diagram illustrates the keyboard interface for entering text. It is divided into three main sections: Entry Prompt, Entry Field, and Keypad.

- Entry Prompt:** Displays "New Password".
- Entry Field:** A dark area where characters are entered, with a green cursor.
- Keypad:** A grid of keys including numbers 0-9, letters QWERTYUIOP, ASDFGHJKL, ZXCVBNM, and symbols. Function keys include Shift, <, >, BackSp, and Enter.

A detailed view of the keypad shows the following functions:

- Char. Selection in the Keypad:** A central area with four arrow keys (up, down, left, right) for navigating through the keypad.
- Transfer character from the keypad to entry field:** A box around the arrow keys and the OK key, indicating that pressing these keys transfers the selected character to the entry field.

Entering the Old Password



Press the **MENU** key and then press the "General Setup" softkey. Select the "System" menu with the help of the Δ scroll key. Switch to the submenu with the help of the \triangleright scroll key and select the **Change Password** parameter using the $\Delta \nabla$ scroll keys. After acknowledging the **Change Password** parameter by pressing the **OK** key, "Old Password" appears in the header in order to prompt you to enter your current password.

Your current password is entered using the alphanumeric keyboard. Select the individual characters from the keypad using the scroll keys to this end. The position of the cursor is indicated by the green background at the respective key. Acknowledge the selected character by pressing the **OK** key, after which the character is transferred to the entry field. The last entered character or characters can be deleted with the help of the **BackSp** (backspace) key. You can move the blinking cursor in the entry field to the desired position within the word using the "<" or ">" softkey, in order to add characters or delete them with the help of the **BackSp** softkey. The **Shift** softkey can be used to switch back and forth between upper and lower case letters, as well as numerals and special characters. A fully entered (old) password is accepted by pressing the **Enter** key. "New Password" appears in the header in order to prompt you to enter a new password.

Entering the New Password

Enter a new password as described above. After acknowledging by pressing the **Enter** softkey, "Confirm Password" appears at the display and prompts you to enter the new password once again. Proceed as described above to enter the password again, and then acknowledge by pressing **OK**. If the exactly the same password has been entered both the first and the second time, the following message appears in order to indicate that the password has been successfully changed: "The password has been changed".

The menu mode is exited by pressing **ESC** three times and the instrument is returned to the measuring function.

4.4.7 System > Display Profile – Digital Display View

Two different views can be selected here – black lettering against a bright background or vice versa.

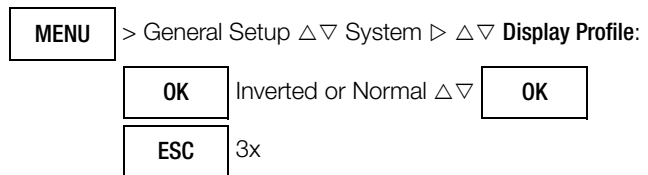

Default setting: White lettering against a dark background

4.4.8 System > Default Settings

All of the settings which you have changed can be returned to their default settings here. The following warning appears after pressing the OK button: "Reset?". The parameter settings are not reset until you acknowledge with "Yes" (scroll with \triangleleft to Yes and press OK). Resetting can be aborted by scrolling with \triangleright to No and pressing OK.

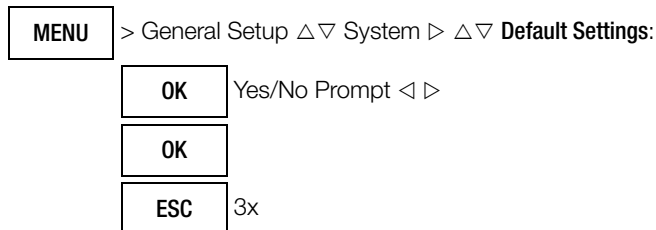

Note

The password for changing the test voltage for insulation resistance measurement is reset to **METRAHIT**.



Note

If you adjust any settings deviating from the default settings, such as „Bluetooth = On“ or „Brightness = Auto“, it may lead to a reduction in the service life specified in the Characteristic Values.

4.5 Switching the Instrument Off

Switching the Instrument Off Manually

- \triangleright The instrument is switched off automatically by setting the rotary switch to the **OFF** position. The display goes blank.

4.5.1 System > Auto-OFF – Automatic Shutdown

The period of time after which the instrument is shut down automatically regardless of whether a measuring or a menu view is open can be set to a value within a range of 10 to 59 minutes.

The instrument is switched off automatically if the measured value remains unchanged for a long period of time (maximum measured value fluctuation of approx. 0.8% of the measuring range per minute or 1°C or 1 ° per minute), and if none of the keys or the rotary switch have been activated before a selected period of time in minutes has elapsed. Shutdown is acknowledged with a brief acoustic signal.

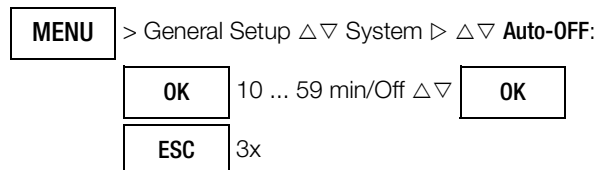

Exceptions

Transmission and memory mode operation, continuous operation and whenever a dangerous voltage is applied to the input ($U > 15$ V AC or $U > 25$ V DC).

Deactivation (continuous operation)

Automatic shutdown can be deactivated.

Set the **Auto-OFF** parameter to **Off** in the **System** submenu of the **General Setup** menu to this end.

5 Control Functions

5.1 Help

The following information can be displayed for switch positions and basic functions after they have been selected with the rotary selector switch:

- Explanation of the measurement
- Measuring ranges
- Wiring diagram

- ⇒ Press the **MENU** key to this end.
- ⇒ Then press the “Help for currently selected measurement” softkey. Comments concerning the measurement are displayed.
- ⇒ By pressing the **1/3** softkey, the measuring ranges and test voltages (2/3) are shown on the display.
- ⇒ The wiring diagram (3/3) is displayed by pressing the **2/3** softkey.
- ⇒ You can return to the help text (1/3) by pressing the **3/3** softkey.
- ⇒ Press the **ESC** key once to return to the menu.
- ⇒ The display can be returned to the measurement by pressing the **ESC** key.

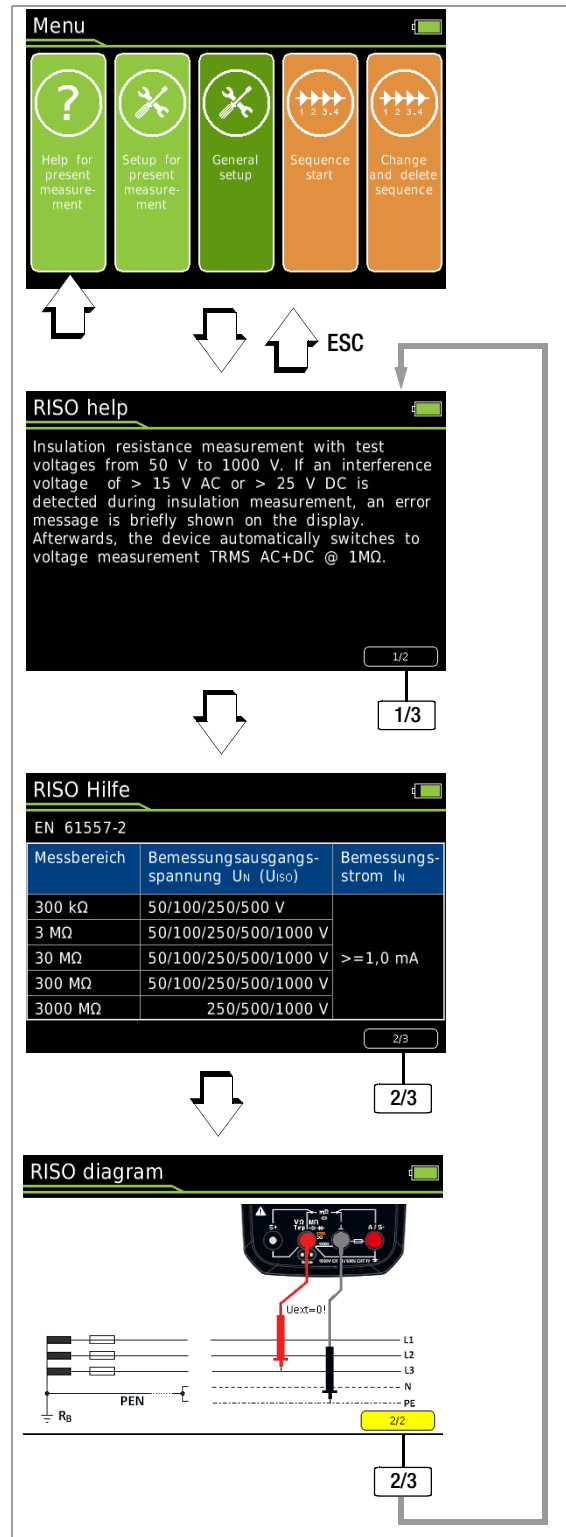

5.2 Selecting Measuring Functions and Measuring Ranges

5.2.1 Automatic Range Selection

The multimeter is equipped with auto-ranging for all measuring functions except for temperature measurement, as well as diode and continuity testing. Auto-ranging is active as soon as the instrument is switched on. The instrument automatically selects the measuring range which allows for highest possible resolution of the applied quantity. When the instrument is switched to frequency measurement, the previously selected voltage measuring range remains active.

AUTO-Range Function

The multimeter is switched automatically to the next higher range at $\pm(3099 d + 1 d \rightarrow 0310 d)$, and to the next lower range at $\pm(280 d - 1 d \rightarrow 2799 d)$.

In the case of high resolution (available depending upon measuring function), the multimeter is switched automatically to the next higher range at $\pm(30,999 d + 1 d \rightarrow 03100 d)$, and to the next lower range at $\pm(2800 d - 1 d \rightarrow 27,999 d)$.

5.2.2 Manual Range Selection

Auto-ranging can be deactivated and measuring ranges can be selected manually in accordance with the following table by pressing the **Man / Auto** button.

The desired measuring range can then be selected with the \langle or \triangleright scroll key.

The instrument is automatically returned to automatic range selection when the **Man / Auto** key is pressed, the rotary switch is activated or the instrument is switched off and back on again.

Overview: Auto-Ranging and Manual Range Selection

	Function	Display
Man / Auto	Manual mode active: utilized measuring range is fixed	Man
\langle or \triangleright	Range switching sequence for: V: 300 mV* \leftrightarrow 3 V \leftrightarrow 30 V \leftrightarrow 300 V \leftrightarrow 1000 V Hz: 300 Hz \leftrightarrow 3 kHz \leftrightarrow 30 kHz \leftrightarrow 300 kHz (Hz(U)) Ω: 300 Ω \leftrightarrow 3 k Ω \leftrightarrow 30 k Ω \leftrightarrow 300 k Ω \leftrightarrow 3 M Ω \leftrightarrow 30 M Ω A: 300 μ A \leftrightarrow 3 mA \leftrightarrow 30 mA \leftrightarrow 300 mA \leftrightarrow 1 A A \mathcal{A}: 0.3 A \leftrightarrow 3 A \leftrightarrow 30 A \leftrightarrow 300 A F: 30 nF \leftrightarrow 300 nF \leftrightarrow 3 μ F \leftrightarrow 30 μ F \leftrightarrow 300 μ F RISO: 300 k Ω \leftrightarrow 3 M Ω \leftrightarrow 30 M Ω \leftrightarrow 300 M Ω \leftrightarrow 3000 M Ω	Man
Man / Auto	Return to automatic measuring range selection	Auto

* Only via manual range selection for V AC

The multimeter is held in the selected measuring range. If the range limit is exceeded, "OL" appears at the display. You should then switch to the next higher measuring range with the help of the \triangleright scroll key.

5.2.3 Quick Measurements

Measurements performed using a suitable fixed measuring range are executed more quickly than those which utilize automatic range selection. Quick measurement is made possible with the following two functions:

- **Manual measuring range selection**, i.e. by selecting the measuring range with the best resolution (see Chapter 5.2.2)

or

- With the **DATA function** (see Chapter 5.5) In this way, the appropriate measuring range is selected automatically after the first measurement and the second measurement is executed more quickly.

The selected measuring range remains active for the subsequent series of measurements with these two functions.

5.3 Zero Offset / Relative Measurements

Zero offset or a reference value for relative measurements can be stored to memory depending upon deviation from the zero point:

Deviation from zero point – with short-circuited measurement cables for V, Ω , A – with open input for capacitance unit of measure F	Display
0 ... 200 digits	ZERO

The relevant reference or correction value is deducted individually for the respective measuring function as an offset from all future measurements and remains in memory until deleted, or until the multimeter is switched off.

Zero balancing and reference value adjustment can be used with auto-ranging, as well as for manual measuring range selection.

Note:

Zero offset is available for the following measuring functions and switch positions: RISO, Coil, DAR, PI, Hz, Duty AC, RPM AC, Ω , Temp RTD (the RLeads function is offered here as an alternative), Temp TC, Continuity, Diode, $R_{L\Omega}/2L$ (ZERO is also activated after pressing the START key!) and $R_{L\Omega}/4L$ (the thermal compensation function is offered here as an alternative).

Zero Balancing

- \triangleright Plug the measuring cables into the instrument and connect the free ends to each other, except for capacitance measurement and current measurement in which case the ends of the cables are not connected to each other.
- \triangleright Briefly press the **Zero** softkey.
The value measured at the moment the key is pressed serves as a reference value. The instrument acknowledges zero balancing with an acoustic signal, and "Zero" and the reference value appear at the display. The **Zero** softkey is displayed with a green background.
- \triangleright Zero balancing can be cleared by once again pressing the **Zero** softkey.



Note

As a result of TRMS measurement, the multimeter displays a residual value of 1 to 10/35 digits with short-circuited measurement cables as the zero point for V AC / I AC or V(AC+DC) / I (AC+DC) measurements (non-linearity of the TRMS converter). This has no influence on specified accuracy above 1% of the measuring range (or 3% in the mV, V(AC+DC) ranges).

Setting the Reference Value

- \triangleright Plug the measuring cables into the instrument and measure a reference value (max. 50% of measuring range).
- \triangleright Briefly press the **Zero** softkey.
The instrument acknowledges storage of the reference value with an acoustic signal and the "ZERO" symbol appears at the display. The value measured at the moment the key is pressed serves as a reference value.
- \triangleright The reference value can be cleared by once again pressing the **Zero** softkey.

Notes Regarding Relative Measurement

- Relative measurement effects the digital display only. The analog display continues to read out the original measured value.
- In the case of relative measurement, Ω F or AC quantities may also appear as negative values.

5.4 Display (TFT)

5.4.1 Digital Display

Measured Value, Unit of Measure, Type of Current, Polarity

The measured value with decimal and plus or minus sign appears at the digital display. The selected unit of measure and current type are displayed as well. A minus sign appears to the left of the value during the measurement of zero-frequency quantities, if the plus pole of the measured quantity is applied to the "⊥" input.

The **Display Zeros** parameter can be used to determine whether leading zeros will appear or be suppressed at the measured value display (see chapter 4.4.5).

Exceeded Measuring Range

If the upper range limit of 1000 digits is exceeded "OL" (overload) appears at the display.

Exceptions: "OL" appears at the display as of 1030.0 V in the case of voltage measurement in the 1000 V range, as of 5100 V for diode testing and as of 1.100 A in the 1 A range.

5.4.2 Analog Display

Measured Value, Polarity

The analog display demonstrates the dynamic performance of a moving-coil mechanism. This display is especially advantageous for observing measured value fluctuation, and for balancing procedures.

Display as a horizontal (green) bar which indicates the current measured value in real-time.

The analog scale displays a small negative range for the measurement of zero-frequency quantities with positive measured values, allowing for precise observation of measured value fluctuation around zero. If the measured value exceeds a certain negative range, polarity is reversed at the analog display.

The analog scale displays a small positive range for the measurement of zero-frequency quantities with negative measured value, allowing for precise observation of measured value fluctuation around zero in this case as well.

Scaling of the analog scale is automatic. This is very helpful for manual measuring range selection.

Exceeded Measuring Range

Exceeding the measuring range is indicated exclusively via the digital display.

Refresh Rate

The analog display is refreshed 40 times per second.

5.5 Measured Value Storage – Data Function (auto-hold/compare)

General

An individual measured value can be automatically “frozen” with the DATA function (auto-hold).

Applications

This function is useful, for example, when contacting the measuring points with the test probes requires your full attention. After the measuring signal has been applied and the measured value has settled in accordance with the “condition” listed in the table below, the measured value is frozen at the digital display and an acoustic signal is generated. The test probes can now be removed from the measuring points, and the measured value can be read from the digital display. If the measuring signal falls below the value specified in the table, the function is reactivated for storage of the next value.

The **Data** function can be activated in all measuring functions. This is possible for the following functions after measurement has been started: RISO, $R_{L\Omega}/2L$ and $R_{L\Omega}/4L$.

Procedure

Apply the measured quantity to the instrument and set the measuring range with the **Man / Auto** softkey before activating the **Data** function with the **Data / MinMax** softkey. **Man** appears at the display with a green background. After activating the **Data** function with the corresponding softkey, **Man** is grayed out and cannot be changed until **Data / MinMax** is pressed again three times for deactivation. **Data** appears at the display with a green background. If automatic measuring range selection was active prior to activation of the **Data** function, switching to manual measuring range selection is also disabled as long as the **MinMax** function is active.

Data and the associated value appear between the digital and analog displays.

Measured Value Comparison (DATA Compare)

If the currently frozen value deviates from the first saved value by less than 100 digits, the acoustic signal is generated twice. If deviation is greater than 100 digits, only a brief acoustic signal is generated.



Note

The **Data** function has no effect on the analog display, at which the current measured value continues to appear. However, when the digital display is “frozen”, the decimal point is fixed as well (fixed measuring range, **Man** appears with a gray-green background).

The selected measuring range cannot be manually changed as long as the **Data** function is active.

The **Data** function is deactivated by briefly pressing the **Data / MinMax** softkey three times, if you switch to the **MinMax** function, when the measuring function is changed or when the instrument is switched off and back on again.

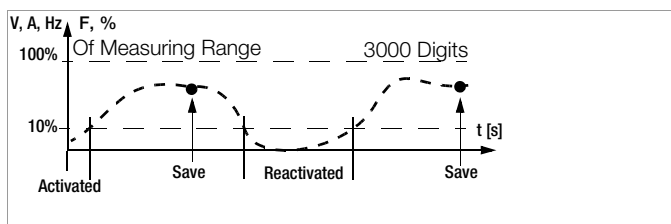

Function Data	Key Data / MinMax	Condition		Response from Instrument	
		Meas. Function	Measuring Signal	Display Data + MV	Acoustic
Activate	Short			Is displayed	1 x
Save (stabilized measured value)		V, A, F, Hz, %	> 10% rdg.	Is displayed	1 x, 2 x ²
			≠ 0L		
Reactivate ¹		V, A, F, Hz, %	< 10% MR	Stored MV	
			= 0L		
Change to MinMax	Short			Is cleared	1 x

¹ Reactivation results from falling short of specified measured value limits.

² Two acoustic signals are generated the first time a measured value is saved as a reference value. For subsequent data hold, two acoustic signals are only generated if the currently frozen value deviates from the **first** saved value by less than 100 digits.

Key: MV = measured value, MR = measuring range

Example

The voltage measuring range is set manually to 30 V. The first measured value is 5 V and is stored to memory because it's greater than 10% of the measuring range (= 3 V), and is thus reliably above the background noise level. As soon as the measured value drops to less than 10 % of the measuring range, i.e. amounts to less than 3 V which corresponds to removal of the test probes from the measuring point, the instrument is ready to store a new value.

5.5.1 Saving Minimum and Maximum Values – “MinMax”

General

Minimum and maximum measured values applied to the measuring instrument's input after the **MinMax** function has been activated can be “frozen” at the display.

Applications

The most important use of this function is the determination of minimum and maximum values during long-term measured value observation. The **MinMax** function can be activated in all measuring functions. This is possible for the following functions after measurement has been started: RISO, $R_{LO}/2L$ and $R_{LO}/4L$.

The **MinMax** function has no effect on the analog display, at which the current measured value continues to appear.

Procedure

Apply the measured quantity to the instrument and set the measuring range with the **Man / Auto** softkey before activating the **MinMax** function with the **Data / MinMax** softkey. **Man** appears at the display with a green background. After activating the **MinMax** function with the corresponding softkey, **Man** is grayed out and cannot be changed until **MinMax** is pressed again for deactivation. **MinMax** appears at the display with a green background. If automatic measuring range selection was active prior to activation of the **MinMax** function, switching to manual measuring range selection is also disabled as long as the **MinMax** function is active.

Both **Min** and **Max**, as well as the associated values, are displayed between the digital and analog displays along with the time of their occurrence.

The **MinMax** function is deactivated by briefly pressing the **Data / MinMax** softkey, when the measuring function is changed or when the instrument is switched off and back on again.



Note

As opposed to the **Data** function, the **MinMax** function can also be used for temperature measurement.

The **MinMax** function is reset by pressing the **ESC** key.

After pressing **Data / MinMax** once again, the minimum and maximum values are displayed together with the average value (“Avg.”). The Min Avg Max display appears without timestamp.

MinMax Function	Data / MinMax Key	Min. and Max. Measured Values	Response from Instrument	
			Display Min + MV Max + MV	Acoustic Signal
Activate and save	Short	Are saved	Current Measured value	1 x
Save and display		Storage continues in background, new min. and max. values are displayed.	Stored min. value	1 x
			Stored max. value	1 x
Stop	Short	Are deleted	Is cleared	1 x

5.6 Measured Value Memory – STORE Function.

The following options are available for the storage of measured values:

- Store at instrument by pressing the **STORE** key on the instrument
- Store at instrument by pressing the **STORE** key on the probe
- Store at the PC by triggering the **PUSH/PRINT** function in the report generating program **IZYTRONIQ**

5.6.1 Remote read-out and storage via the Z270S probe

The probe with integrated control unit permits remote triggering at difficult to access places, and at locations which require your full attention. The probe can be used for all measuring functions except for current measurement. The connector cable is shielded against interference.

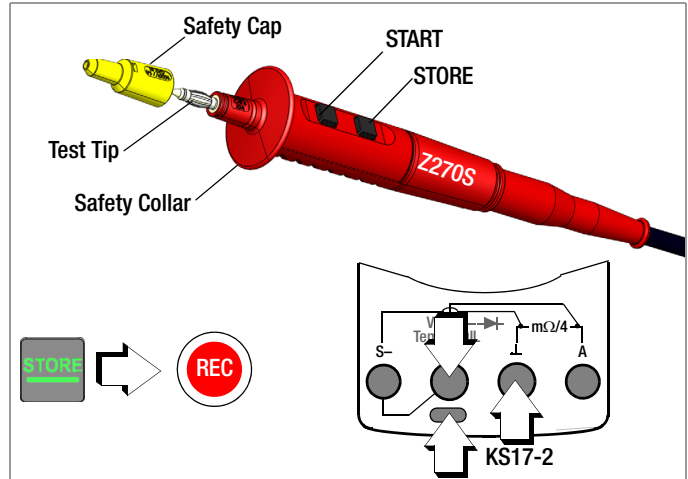

- Connect the probe's double plug to the voltage socket (V).
- Connect the KS17-2 safety measurement cable to the ground socket.
- Establish contact with the measuring point.
- Start the respective measuring function by pressing the **START** key on the probe.
- As soon as the measured value has settled in, it can be stored by pressing the **STORE** key on the probe. Alternatively, the measured value can be stored with the help of the **STORE** key on the instrument.

The **REC** storage symbol appears briefly in the header in order to visualize the storage process.

Electrical Safety

Maximum rated voltage	300 V	600 V	600 V
Measuring category	CAT IV	CAT III	CAT II
Maximum rated current	1 A	1 A	16 A
With safety cap attached	•	•	—
Without safety cap	—	—	•

Measurements per DIN EN 61010-031 may only be performed in environments in accordance with measuring categories III and IV with the **safety cap** attached to the control unit's test tip.

In order to **establish contact inside 4 mm sockets**, the safety cap has to be removed by prying open the snap fastener with a pointed object (e.g. the other test probe).

5.6.2 Remote Read-Out and Storage via the PC – PUSH/PRINT Function

The procedure for storage via the **PUSH/PRINT** function is described in the online help included with **IZYTRONIQ** report generating software.

5.7 Measurement Data Recording

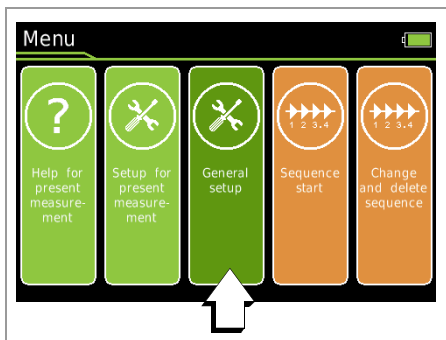

The multimeter is capable of recording measurement data with adjustable sampling rates, hysteresis and trigger conditions for long periods of time in the form of measurement series (Parameter Record type = Periodic). Data are stored to a battery-backed memory module, and are retained even after the multimeter is switched off. The system acquires measured values relative to real-time.

Momentary or stored measurement data can be read out via a bidirectional wireless interface, Bluetooth or WiFi, or the USB port at the optional mains module. **IZYTRONIQ** software is required to this end.

See also interface operation chapter 7.

- ⇨ First set the sampling rate for memory mode operation (see below).
- ⇨ Set recording time to **Unlimited** or to a value within a range of 0:00:00 to 90:00:00.
- ⇨ Select an hysteresis in order to assure efficient use of memory capacity.
- ⇨ Select a trigger function if required.
- ⇨ Check current memory occupancy (see below).
- ⇨ Before starting lengthy measured value recordings, check the battery's charge level (see chapter 4.1) or use the mains module.
- ⇨ Start memory mode operation (see below).
- ⇨ First select the desired measuring function and an appropriate measuring range.

General Setup		
System	Recording	Start
Memory	Record type	Periodic
Interface	Sampling rate	00:00.5
Information	Recording time	Unlimited
Language	Hysteresis	Off
	Trigger	Within
	Trigger, low limit	+00000
	Trigger, high limit	+01000
	Groups	...
	Clear memory	...

Setting the Record Type

In this menu, you can choose between a definable periodic and fixed sampling rate (parameter **Periodic**) and a one-off storage of a data value by means of the **STORE** key (parameter **Data Value**).

- ⇨ Press the **MENU** key.
- ⇨ Press the **General setup** softkey.
- ⇨ Select the **Memory** menu with the $\Delta \nabla$ scroll keys.
- ⇨ Switch to the submenu with the help of the \triangleright scroll key.
- ⇨ Select the **Record type** parameter with the $\Delta \nabla$ scroll keys.
- ⇨ Acknowledge the selected parameter by pressing the **OK** key.
- ⇨ Change the respective value using the $\Delta \nabla$ scroll keys.
- ⇨ Acknowledge the change with the **OK** key. The entry cursor once again marks the entire parameter line.

MENU > General setup $\Delta \nabla$ Memory \triangleright $\Delta \nabla$ Record type
Periodic / Data Value

OK

Setting the Sampling Rate

This parameter cannot be set during memory mode operation. Proceed as follows in order to set the sampling rate:

- ⇨ Press the **MENU** key.
- ⇨ Press the **General Setup** softkey.
- ⇨ Select the **Memory** menu with the $\Delta \nabla$ scroll keys.
- ⇨ Switch to the submenu with the help of the \triangleright scroll key.
- ⇨ Select the **Sampling Rate** parameter with the $\Delta \nabla$ scroll keys.
- ⇨ Acknowledge the selected parameter by pressing the **OK** key.
- ⇨ Change the respective value using the $\Delta \nabla$ scroll keys [h:mm:ss] or [mm:ss/s/10].
- ⇨ Acknowledge the change with the **OK** key. The entry cursor once again marks the entire parameter line.

MENU > General Setup $\Delta \nabla$ Memory \triangleright $\Delta \nabla$ Sampling Rate
[h:mm:ss] / Data Value

OK

Adjusting Recording Time

This parameter cannot be set during memory mode operation. Proceed as follows in order to set recording time:

- ⇨ Press the **MENU** key.
- ⇨ Press the **General Setup** softkey.
- ⇨ Select the **Memory** menu with the $\Delta \nabla$ scroll keys.
- ⇨ Switch to the submenu with the help of the \triangleright scroll key.
- ⇨ Select the **Recording Time** parameter with the $\Delta \nabla$ scroll keys.
- ⇨ Acknowledge the selected parameter by pressing the **OK** key.
- ⇨ Change the respective value using the $\Delta \nabla$ scroll keys [h:mm:ss].
- ⇨ Acknowledge the change with the **OK** key. The entry cursor once again marks the entire parameter line.

MENU > General Setup $\Delta \nabla$ Memory \triangleright $\Delta \nabla$ Recording Time
[h:mm:ss]

OK

Setting Hysteresis

The hysteresis setting allows for efficient use of memory space. During memory mode operation, new measured data are only saved if they deviate from the previously stored value by an amount which exceeds the selected hysteresis value.

Hysteresis can be selected in steps from 1 to 10,000 digits. These digits are related to the measuring range as follows: The position of the set digit in the specified hysteresis value corresponds to the same position within the measuring range, although counting is started at the left.

Example: A specified hysteresis of 00100 for the 300.00 V measuring range means that only those measured values which deviate from the last measured value by more than 001.00 V are saved to memory.



Note

Due to the fact that the value is specified in digits (highest place all the way to the left), and thus depends on the measuring range, it's advisable to use the function with a fixed measuring range only.

This parameter cannot be set during memory mode operation. Proceed as follows in order to activate and set hysteresis:

- ⇨ Press the **MENU** key.
- ⇨ Press the **General Setup** softkey.
- ⇨ Select the **Memory** menu with the $\Delta\nabla$ scroll keys.
- ⇨ Switch to the submenu with the help of the \triangleright scroll key.
- ⇨ Select the **Hysteresis** parameter with the help of the $\Delta\nabla$ scroll keys.
- ⇨ Acknowledge the selected parameter by pressing the **OK** key.
- ⇨ If the parameter is set to off, activate hysteresis by a pressing the Δ scroll key.
- ⇨ Then select the desired entry position within the parameter using the $\triangleleft\triangleright$ scroll keys and change the respective value (00000 digits) with the $\Delta\nabla$ scroll keys.
- ⇨ Acknowledge the change with the **OK** key. The entry cursor once again marks the entire parameter line.

MENU > General Setup $\Delta\nabla$ Memory \triangleright $\Delta\nabla$ Hysteresis
OK

- ⇨ Hysteresis is deactivated again by selecting the first digit or the leading zero of the display hysteresis value, pressing the ∇ scroll key and acknowledging with **OK**.

Trigger Mode Operation

The **Off**, **Outside** and **Within** settings can be used to specify how measured value recording is started and stopped:

- **Trigger = Off:** Storage is started with **Recording > Start** and ended with **Recording > Stop**.
- **Trigger = Outside:** Recording is started as soon as a measured value occurs which is outside of the selected measuring limits, and is stopped as soon as this is no longer the case, or after selected **Recording Time** is exceeded.
- **Trigger = Within:** Recording is started as soon as a measured value occurs which is within a specified band, and is stopped as soon as this is no longer the case, or after maximum **Recording Time** has elapsed.

The band is specified with the help of the lower trigger limit (**Trigger Low Limit**) and the upper trigger limit (**Trigger High Limit**). The limits are entered in digits and are defined by the upper range limit. In the case of DC, for example, this is 30.000 (-30.000 to +30.000).

For measuring functions with a minimal measuring-range span, for example R_{LO} or $m\Omega/4$ with 3000 digits, setting the trigger

threshold above this measuring range limit does not make sense. It's thus advisable to perform measurement with a fixed measuring range.

Actual measurement is always executed using the selected sampling rate.



Note

Measurements performed close to the trigger level may result in an incorrect display. If this is the case, select a smaller voltage measuring range. In the case of measured values which are much higher than the expected results, the input signal may be distorted. Perform measurement with activated 1 kHz low-pass filter in this case.

Activating the Trigger

The trigger function cannot be set during memory mode operation. Proceed as follows in order to activate and set the trigger function:

- ⇨ Press the **MENU** key.
- ⇨ Press the **General Setup** softkey.
- ⇨ Select the **Memory** menu with the $\Delta\nabla$ scroll keys.
- ⇨ Switch to the submenu with the help of the \triangleright scroll key.
- ⇨ Select the **Trigger** parameter with the $\Delta\nabla$ scroll keys.
- ⇨ Acknowledge the selected parameter by pressing the **OK** key.
- ⇨ Select the respective function (within, outside or off) with the help of the $\Delta\nabla$ scroll keys.
- ⇨ Acknowledge the change with the **OK** key. The entry cursor once again marks the entire parameter line.

MENU > General Setup $\Delta\nabla$ Memory \triangleright $\Delta\nabla$ Trigger
OK

Adjusting the Trigger Threshold

These parameters cannot be set during memory mode operation. Proceed as follows in order to set the upper and lower trigger thresholds:

- ⇨ Press the **MENU** key.
- ⇨ Press the **General Setup** softkey.
- ⇨ Select the **Memory** menu with the $\Delta\nabla$ scroll keys.
- ⇨ Switch to the submenu with the help of the \triangleright scroll key.
- ⇨ Select the **Trigger Low Limit** or **Trigger High Limit** parameter with the help of the $\Delta\nabla$ scroll keys.
- ⇨ Acknowledge the selected parameter by pressing the **OK** key.
- ⇨ Select the desired entry position within the parameter using the $\triangleleft\triangleright$ scroll keys and change the respective value with the $\Delta\nabla$ scroll keys.
- ⇨ Acknowledge the change with the **OK** key. The entry cursor once again marks the entire parameter line.

MENU > General Setup $\Delta\nabla$ Memory \triangleright $\Delta\nabla$ Trigger Low Limit +00000 digits / Trigger High Limit +00000 digits
OK

Creating Groups

Groups can be created here in order to be able to sort measured values when they're saved. As is also the case when the password is changed, entries are made using a keyboard which appears at the display (see chapter 4.4.6). Before starting the respective measurement, select a suitable group from the list you've created to which the measured values will be saved.

MENU > General Setup $\Delta\nabla$ Memory \triangleright $\Delta\nabla$ **Groups**

Querying Memory Occupancy

You can query memory occupancy from within the "Info" menu before as well as during the save operation.

Memory occupancy range: 000.1% ... 099.9%.

MENU > General Setup $\Delta\nabla$ Info > Memory Occupancy x.x%

Starting Recording via Menu Functions

Proceed as follows in order to start recording:

- ⇨ Press the **MENU** key.
- ⇨ Press the **General Setup** softkey.
- ⇨ Select the **Memory** menu with the $\Delta\nabla$ scroll keys.
- ⇨ Switch to the submenu with the help of the \triangleright scroll key.
- ⇨ Select the **Start Recording** parameter with the $\Delta\nabla$ scroll keys.
- ⇨ Acknowledge the selected parameter by pressing the **OK** key.

The "Start" setting changes to "Stop".

The following message appears: "Measurement has begun." At the same time, "REC" appears in red to the left of the battery level display.

MENU > General Setup $\Delta\nabla$ Memory \triangleright $\Delta\nabla$ **Start Recording**

OK > **Stop**

- ⇨ The display is returned to the measuring function by pressing the **ESC** key three times.

Ending Recording

Proceed as follows in order to stop recording:

- ⇨ Press the **MENU** key.
- ⇨ Press the **General Setup** softkey.
- ⇨ Select the **Memory** menu with the $\Delta\nabla$ scroll keys.
- ⇨ Switch to the submenu with the help of the \triangleright scroll key.
- ⇨ Select the **Stop Recording** parameter with the $\Delta\nabla$ scroll keys.
- ⇨ Acknowledge the selected parameter by pressing the **OK** key.

The "Start" setting changes to "Stop".

The following message appears: "Measurement has been ended".

The red "REC" symbol is cleared from the display.

MENU > General Setup $\Delta\nabla$ Memory \triangleright $\Delta\nabla$ **Stop Recording**

OK > **Start**

- ⇨ The display is returned to the measuring function by pressing the **ESC** key three times.
- ⇨ Memory mode operation can also be exited by switching the multimeter off.

Clearing Memory (deleting measured values)

This function deletes all measured values from memory!

This function cannot be executed during memory mode operation.

MENU > General Setup $\Delta\nabla$ Memory \triangleright $\Delta\nabla$ **Clear Memory**

The following security prompt appears before memory is cleared: "Clear memory?". This prompt must be acknowledged with "Yes" via the function key (not with OK).

Confirmation is displayed at the end of the operation: "Memory has been cleared."

6 Measurements

6.1 Enabling Parameter Changes

A password must be entered in order to adjust the parameters for each of the following measurements:

- RISO: change test voltage
- $m\Omega/4$: change test current

Entering the Password for Changing Parameters

As soon as you attempt to change, for example, test voltage U_{set} via the $\Delta \nabla$ scroll keys, the “Password” menu appears. Enter the current password as described in chapter 4.4.6.



Note

If you've forgotten your password, please contact our product support department (see phone number in chapter 1.1).

Changing the Password

A previously selected password can be changed in the “General Setup” menu (see chapter 4.4.6).

6.2 Insulation Resistance Measurement – RISO Function

6.2.1 Preparing for Measurement



Note

Checking the Measurement Cables

The test probes at the ends of the measurement cables should be short circuited before performing insulation resistance measurements with the selector switch in the Ω position, in order to make sure that a value close to 0Ω is displayed at the instrument. In this way, incorrect connection can be avoided and broken measurement cables can be detected.

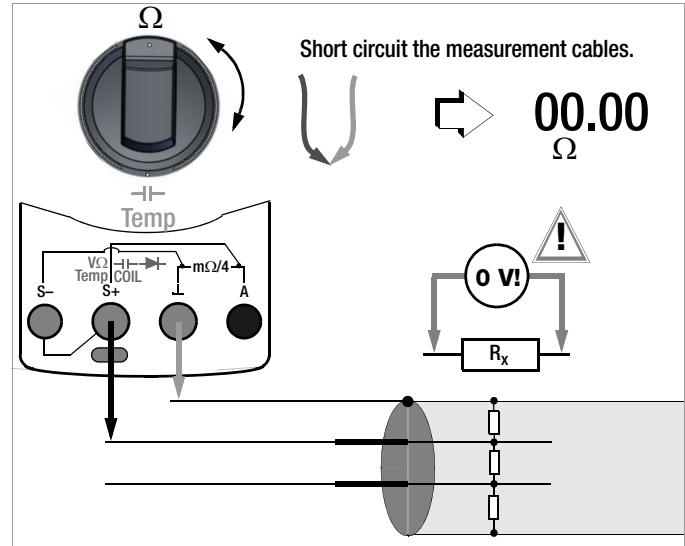

Note

Insulation resistance may only be measured at voltage-free devices. The measurement cables may not come into contact with one another during high-resistance insulation measurements.

- Set the rotary switch to “RISO” or “COIL”.
- Connect the measurement cables to the accessible $M\Omega$ and \perp sockets, using the included probe for connection to the $M\Omega$ socket if possible.
- Interference voltage measurement (V AC+DC TRMS) is conducted in this switch position.

The **START** key may only be pressed when the device under test is voltage-free (display: $U_{ext} < 10 \text{ V}$).

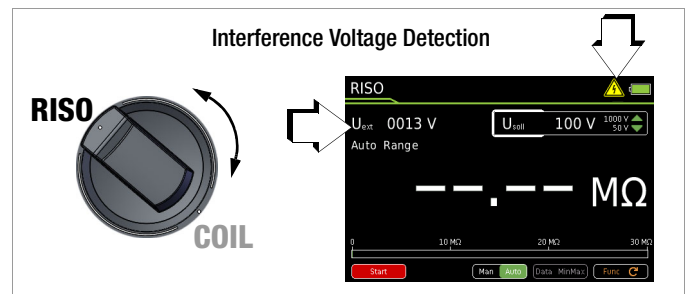

Note

The “RISO” or “COIL” switch position may only be used for insulation resistance measurement and short-circuited coil detection. However, if interference voltage is inadvertently applied with the switch in this position, it appears at the display. If an interference voltage of $U_{ext} > 15 \text{ V AC}$ or $> 25 \text{ V DC}$ is present within the system, insulation resistance measurement is disabled. The display panel continues to show the interference voltage value. If a voltage of greater than 1000 V is present, an acoustic signal is generated as well.



Caution: High-Voltage!

Do not touch the conductive ends of the test probes when the instrument has been activated for the measurement of insulation resistance.

You may otherwise be exposed to a current of 2.5 mA (limited in the measuring instrument), and although this is not life endangering, the resulting electrical shock is quite discernible.

If, on the other hand, measurement is being performed on a capacitive device under test, for example a cable, it may be charged with up to approximately ± 1200 V. **Touching the device under test after measurement has been performed is life endangering in this case!**

Selecting the Test Voltage ($U_{set} = 50 \dots 1000$ V)

- ⇒ Select the desired test voltage U_{set} with the \blacktriangle / \blacktriangledown scroll keys.
- ⇒ It may be necessary to enter a password in order to change test voltage (see chapter 6.1).

The selected test voltage appears at the display during testing.

RISO

COIL

The above symbol blinks when test voltage is connected.

RISO

U_{ext} 0000 V U_{set} 100 V 1000 V 50 V

Auto Range

MΩ

Coil

Value + 57.4 μ s

Value - 57.1 μ s

Deviation 030.7 %

DAR

DAR 1,00 Riso --- MΩ

U_{ext} 0000 V

U_{set} 100 V

t_{act} 60 s

R_{30} 20.09 MΩ

R_{60} 20.10 MΩ

PI

PI --- Riso 100,0 MΩ

U_{BO} 0110 V

U_{set} 100 V

t_{act} 141 s

R_{60} 100.1 MΩ

R_{600} --- MΩ

6.2.2 Performing Insulation Measurement

- ⇒ When the device under test is voltage-free, activate the measurement by pressing the **Start** softkey on the instrument or on the probe.
- ⇒ Don't read the measurement results until the display has settled in. The high-voltage symbol next to the battery level display blinks during measurement.

Auto-ranging is active during insulation resistance measurement.

A DATA function which is matched specifically to the insulation measurement can be activated for automatic retention of valid measured values (see chapter 5.2.1).

Automatic Detection of Interference Voltage During Insulation Measurement

If the instrument detects interference voltage of greater than **15 V AC or > 25 V DC** (condition: $U_{ext} \neq U_{INS}$, e.g. $R_{iq} < 100$ kΩ at 100 V, see page 48, footnote 1), the instrument is switched automatically to voltage measurement and the currently measured voltage value is displayed as U_{ext} .



Note

A dead zone results in erroneous measurements for automatic interference voltage detection during insulation measurement. The dead zone lies within a range of 80% to 120% of the selected test voltage (in the case of an interference voltage whose value is equal to that of measuring voltage, the two voltages neutralize each other).

Manual switching to insulation resistance measurement is disabled for as long as voltage is applied to the test terminals.

If interference voltage is no longer present, insulation measurement can be started by pressing the **Start** softkey once again.



Attention!

If "Error" appears at the display, the cable (the device under test) is most likely capacitively charged to a significant extent. Remedy: Short circuit the cable (the device under test). Repeat the measurement.

6.2.3 Ending the Measurement and Discharging

- ⇒ Press the **Start** softkey in order to end the measurement.

A warning is displayed during the discharging procedure which isn't cleared from the display until applied voltage $U_{ext} = 0000$ V.

The instrument's internal 1 MΩ resistor causes rapid discharging. Contact between the object and the instrument must not be interrupted. **Do not disconnect the object until voltage has fallen below 25 V and the warning has been cleared from the display!**

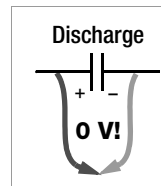

Note

Voltage measurement in the **RISO** or **COIL** switch position is used primarily for interference voltage detection before the respective measurement.

Use the V_{\sim} , $V_{\text{---}}$ or $V_{\text{---}}$ switch position in order to perform precise voltage measurements.

6.3 Short-Circuited Coil Measurement – COIL Function

In combination with the optional **COIL TEST ADAPTER**, short-circuited coil measurements with a test voltage of 1000 V are possible within an inductance range of 10 μH to 50 mH at 100 Hz. This range corresponds to motors in accordance with DIN standards with power ratings of roughly 15 kVA to 80 MVA.

A semi-periodic time value which is proportional to the inductance of the respective coil is ascertained during this measurement by means of cyclical discharging with high-voltage for each motor coil or coil combination, one after the other. A comparison of the measurement results makes it possible to examine the motor coils for symmetry, and thus to detect a short-circuited coil.

6.3.1 Preparing for Measurement

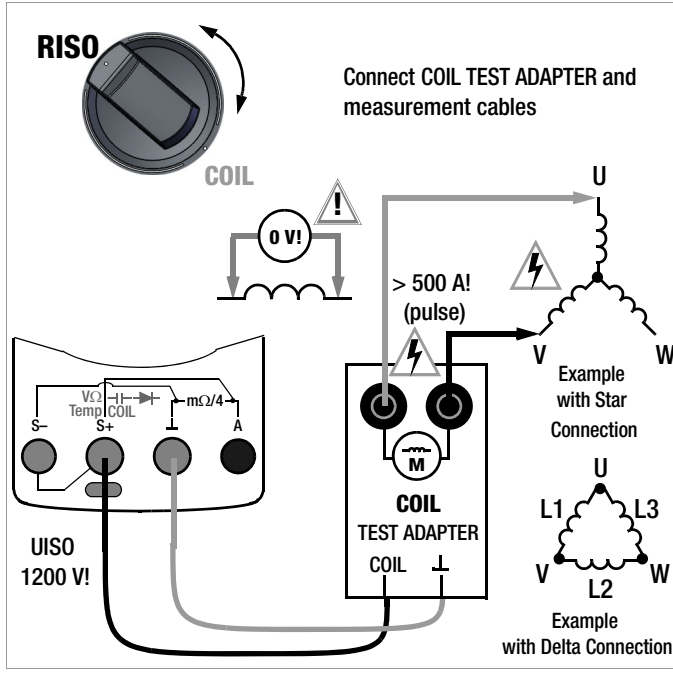

Note
Short-circuited coil measurements may only be conducted on voltage-free coils.

- Set the rotary switch to “RISO” or “COIL”.
- Repeatedly press the **Func** softkey until the measurement view for **COIL** appears at the display.
- Select the motor or coil type to be tested under the measurement type parameter in “Setup for currently selected measurement” (see below).

Selecting the Type of Measurement

MENU > Momentary Measurement Setup > Parameter \triangleright $\Delta \nabla$ Measurement Type

OK $\Delta \nabla$ Coil / 1-Ph. Motor / 3-Ph. Motor **OK**

ESC 3 x > Measurement View

1-Ph. Motor: AC motor (L1)
3-Ph. Motor: 3-phase motor (L1, L2, L3)
Coil: Motor with up to 15 coils (L1 - L15)

- Select polarity: unipolar or bipolar (see below).

Polarity Selection

MENU > Momentary Measurement Setup > Parameter \triangleright $\Delta \nabla$ Polarity

OK $\Delta \nabla$ Bipolar / Unipolar **OK**

ESC 3 x > Measurement View

RISO

U_{set} 0000 V U_{coil} 100 V 1000 V 50 V

Auto Range

MΩ

Start Man Auto Data MinMax Func

Coil

Value + 57.4 μs
Value - 57.1 μs
Deviation 030.7 %

Start List Delete Func

DAR

DAR 1.00 Riso ---, MΩ

U_{set} 0000 V
U_{coil} 100 V
t_{set} 60 s
R_{pos} 20.09 MΩ
R_{neg} 20.10 MΩ

Start Func

PI

PI ---- Riso 100.0 MΩ

U_{ISO} 0110 V
U_{set} 100 V
t_{set} 141 s
R_{pos} 100.1 MΩ
R_{neg} --- MΩ

Stop Func



The above symbol blinks when test voltage is connected.

Test voltage (U_{set} = 1000 V)

Test voltage for the short-circuited coil measurement is permanently set to 1000 V and cannot be changed.

Connection and Contacting

- Connect the **COIL TEST ADAPTER** via the contact protected plug of its connector cable to the two accessible sockets at the multimeter: i.e. the red cable to the **COIL** socket and the black cable to the \perp socket.
- Connect the two measurement cables to the sockets at the **COIL TEST ADAPTER** (identified with motor symbol).
- If possible, contact the inductive device under test with optional alligator clips plugged onto the test probes. In the case of 3-phase motors, for example, contact coil terminals U-V, V-W and U-W or L1, L2 and L3, one after the other.
- Interference voltage measurement (V AC+DC TRMS) is conducted in this switch position.
- The short-circuited coil measurement may only be started when the device under test is voltage-free.



Note

The "RISO" or "COIL" switch position may only be used for short-circuited coil detection. However, if interference voltage is inadvertently applied with the switch in this position, it appears at the display. If an interference voltage of > 50 V is present, the short-circuited coil measurement is disabled. The "Caution High-Voltage" symbol continues to appear at the display. If a voltage of greater than 1000 V is present, an acoustic signal is generated as well.



Caution: High-Voltage!

Do **not** touch the conductive ends of the test probes as long as measurement is active and the **Stop** softkey is displayed. A voltage of up to 1200 V is present at the multimeter's two enabled output sockets, and as a pulsed voltage at the two output sockets of the **COIL TEST ADAPTER** (identified with motor symbol).

Multimeter: You may otherwise be exposed to a current of 2.5 mA (limited in the measuring instrument), and although this is not life endangering, the resulting electrical shock is quite discernible.

COIL TEST ADAPTER: Power pulse currents of greater than 500 A can flow from the output sockets.

The device under test can become charged: Wait until voltage at the device under test has been discharged after each measurement (message: „Discharge ...“). Touching the device under test may otherwise be life endangering!

Measured Value Displays

Graphic

Graphic representation is used as a standard feature for the measurement view. If the instrument is in the list view, you can switch to the graphic display by pressing the **Graphic** softkey.

Horizontal axis: Coil L1, L2, L3 ...

Vertical axis: Discharging time in μ s

The currently measured discharging time for the coil selected with the scroll key is digitally displayed in microseconds to the right of the bar graph. As of the second measurement, deviation from the smallest to the largest measured value is additionally displayed as a percentage.

- You can delete each measurement in order to repeat it by selecting the desired axis position for coil L1, L2 or L3 with the < or > scroll key and pressing the **Delete** softkey.

List

You can switch to the list view anytime by pressing the **List** softkey. In this case, deviation from the previous value, as well as date and time of the measurement, are listed along with the respective measured values. The final comparison of all measurements appears in the table's header.

- You can delete each measurement in order to repeat it by selecting the desired table row for coil L1, L2 or L3 with the Δ or ∇ scroll key and pressing the **Delete** softkey.

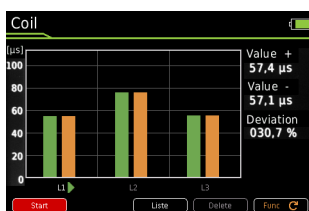

Graphic Representation

Nr	+COIL	-COIL	ΔCOIL±	ΔCOIL3	Date / Time
1					
2					
3					

List View

6.3.2 Conducting the Short-Circuited Coil Measurement

- Contact the desired coil (e.g. U–V) in order to test for absence of voltage.



Attention!

Do not establish contact manually – use a self-retaining contacting method instead, for example with the help of alligator clips. Poor contact may result in sparking and if the contacting element slips off of the device under test, the inspector is exposed to life-threatening danger!

➤ Activating the Short-Circuited Coil Measurement

Activate the measurement by pressing the **Start** softkey. The high-voltage symbol next to the battery level display blinks during measurement.

- Measurement is stable as soon as a bar graph appears along with the associated discharging time specified in microseconds to the right of the bar graph and deviation to the previous measurement is displayed as a percentage for the respective coil L.
- End measurement by pressing the **Stop** softkey.
- Before removing the contacting element, allows the coil to discharge via the multimeter (see chapter 6.3.3).
- Measurement for motors with three or more coils: Connect the next coil (e.g. V–W) and repeat the measurement procedure described above. The next coil is automatically incremented in the measurement display and activated.

Automatic Evaluation of Measurement Results

Automatic evaluation of measurement results begins when the second measurement is started. The respective measurement view (graph or list view) shows maximum deviation to the previous measurement as a percentage. This permits direct comparison of the first and all subsequent measurements. Due to the fact that the third measurement is then compared with the results of both previous measurements, you automatically get a final comparison of all three measurements.

The list view permits a final comparison of all measured motor coils (star or delta connection).

Permissible asymmetry depends on motor type:

A motor with squirrel-cage rotor demonstrates only minimal asymmetry (typically 1%). If deviation is greater than 10%, the device under test is faulty (e.g. short-circuited coil).

If any of the measured values is 0, there's a short-circuit. If no discharging takes place, the measured coil is interrupted.

In order to start a new measurement series, delete the recorded measurement for each coil as described under "Measured Value Displays" or reselect the **Coil** function with the **Func** softkey (or by turning the rotary switch).

In the case of permanent-field motors, short-circuited coil measurement is not dependent on rotor position. This also applies to squirrel cage motors with large inductances which result in more frequently occurring remanence. In this case, the bipolar setting must be selected for the short-circuited coil measurement. First of all, measurement must be performed at each coil with positive polarity. Afterwards, each coil is measured once again with reversed polarity. The connections between the coil adapter's terminals and the motor coil are reversed to this end. The instrument generates a mean value based on both measurement results which, to a great extent, is independent of rotor position.

6.3.3 Ending the Measurement and Discharging

⇒ End the respective measurement by pressing the **Stop** softkey.

After ending the measurement, any remaining residual voltage (U_{ext}) is displayed (message: „Discharge ...“), which may result from cable capacitance. The instrument's internal $1\text{ M}\Omega$ resistor causes rapid discharging.

Contact to the motor coils must be retained to this end. Do not disconnect the object until voltage has fallen below 25 V, i. e. message „Discharge ...“ disappears.

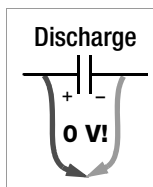

Note

Voltage measurement in the **RISO** or **COIL** switch position is used primarily for interference voltage detection before the respective measurement.

Use the V_{\sim} , V_{DC} or V_{AC} switch position in order to perform precise voltage measurements.

6.4 Absorption Index Measurement – DAR

The absorption index test is part of the polarization index test (PI). Insulation resistance measurements are placed in relationship to one another after 30 and 60 seconds.

Application: faster version of the polarization index test.

- Set the rotary switch to “RISO”.
- Repeatedly press the **Func** softkey until the measurement view for **DAR** appears at the display.
- Contact the device under test with alligator clips which have been plugged onto the test probes.
- Interference voltage measurement (V AC+DC TRMS) is conducted in this switch position.
- Measurement may only be started when the device under test is voltage-free ($U_{ext} = 0000\text{ V}$).
- Activate the measurement by pressing the **Start** softkey. The high-voltage symbol next to the battery level display blinks during measurement.
- You can interrupt the measurement at any time by pressing the **Stop** softkey.

The measurement is recorded and you can observe its progress which is displayed as a curve over the time axis.

The result for R_{30} is displayed after reaching the 30 s mark. Measurement is stopped automatically and results for R_{60} and **DAR** are displayed after reaching the 60 s mark.

The following measured values are displayed digitally next to the graphic representation:

DAR	Absorption index after 60 s
RISO	Momentary measured value in $M\Omega/G\Omega$
U_{ext}	Momentary measuring voltage (actual value)
U_{set}	Test voltage (target value)
t_{act}	Measured time since beginning of measurement
R_{30}	Measured value after 30 s in $M\Omega/G\Omega$
R_{60}	Measured value after 60 s in $M\Omega/G\Omega$

After measurement has been completed, any remaining residual voltage U_{ext} is displayed which may result from cable capacitance and a capacitive device under test. The instrument's internal $1\text{ M}\Omega$ resistor causes rapid discharging.

Contact to the insulation resistance must be retained to this end.

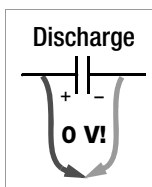

RISO

COIL

RISO

$U_{ext} 0000\text{ V}$ $U_{set} 100\text{ V}$ 1000 V
50 V

Auto Range

--- M Ω

0 10 M Ω 20 M Ω 30 M Ω

Start Man Auto Data Min/Max Func

Coil

Value + 57.4 μs
Value - 57.1 μs
Deviation 030.7 %

Start List Delete Func

DAR

DAR 1,00 Riso ---, - M Ω

$U_{ext} 0000\text{ V}$
 $U_{set} 100\text{ V}$
 $t_{act} 60\text{ s}$
 $R_{30} 20,09\text{ M}\Omega$
 $R_{60} 20,10\text{ M}\Omega$

Start Func

PI

Riso 100,0 M Ω

$U_{iso} 0110\text{ V}$
 $U_{set} 100\text{ V}$
 $t_{act} 141\text{ s}$
 $R_{30} 100,1\text{ M}\Omega$
 $R_{60} ---, -\text{ M}\Omega$

Stop Func

The above symbol blinks when test voltage is connected.

6.5 Polarization Index Measurement – PI

Polarization index testing is recommended for electric machines. This procedure involves expanded testing of insulation resistance. DC measuring voltage from the multimeter is applied to the insulation for a duration of 10 minutes. Measured values are documented after one minute, and after ten minutes. If the insulation is good, the value measured after ten minutes is higher than the value measured after one minute. The relationship between the two measurement values is the polarization index. Charged material within the insulation is aligned due to the application of measuring voltage over a long period of time, resulting in polarization. The polarization index indicates whether or not the charged material contained in the insulation can still be moved, i.e. whether or not polarization is possible at all. This, in turn, is an indication of the condition of the insulation.

The following rules apply in general:

- PI values < 1:** Troubleshooting is required.
- PI values = 1 ... 2** Maintenance is recommended
- PI values = 2 ... 4** DUT is OK, no immediate action is required. Preventive maintenance can be planned according to workload.
- PI values > 4** DUT in flawless condition

Applications: Determination of moisture and contamination levels

The following applies to the insulation of electric drive units:

- Intact insulation $PI \geq 2$
- Very good insulation $PI > 4$

- Set the rotary switch to “RISO”.
- Repeatedly press the **Func** softkey until the measurement view for **PI** appears at the display.
- Contact the device under test with alligator clips which have been plugged onto the test probes.
- Interference voltage measurement (V AC+DC TRMS) is conducted in this switch position.
- Measurement may only be started when the device under test is voltage-free ($U_{ext} = 0000$ V).
- Activate the measurement by pressing the **Start** softkey. The high-voltage symbol next to the battery level display blinks during measurement.
- You can interrupt the measurement at any time by pressing the **Stop** softkey.

The measurement is recorded and you can observe its progress which is displayed as a curve over the time axis.

The result for R_{60} is displayed after reaching the 60 s mark. Measurement is stopped automatically and results for R_{600} and **DAR** are displayed after reaching the 600 s mark.

The following measured values are displayed digitally next to the graphic representation:

- PI Polarization index after 600 s
- Riso Momentary measured value in $M\Omega/G\Omega$
- U_{ext} Momentary measuring voltage (actual value)
- U_{set} Test voltage (target value)
- t_{act} Measured time since beginning of measurement
- R_{60} Measured value after 60 s in $M\Omega/G\Omega$
- R_{600} Measured value after 600 s in $M\Omega/G\Omega$

After measurement has been completed, any remaining residual voltage U_{ext} is displayed which may result from cable capacitance and a capacitive device under test. The instrument's internal $1\text{ M}\Omega$ resistor causes rapid discharging.

Contact to the insulation resistance must be retained to this end.

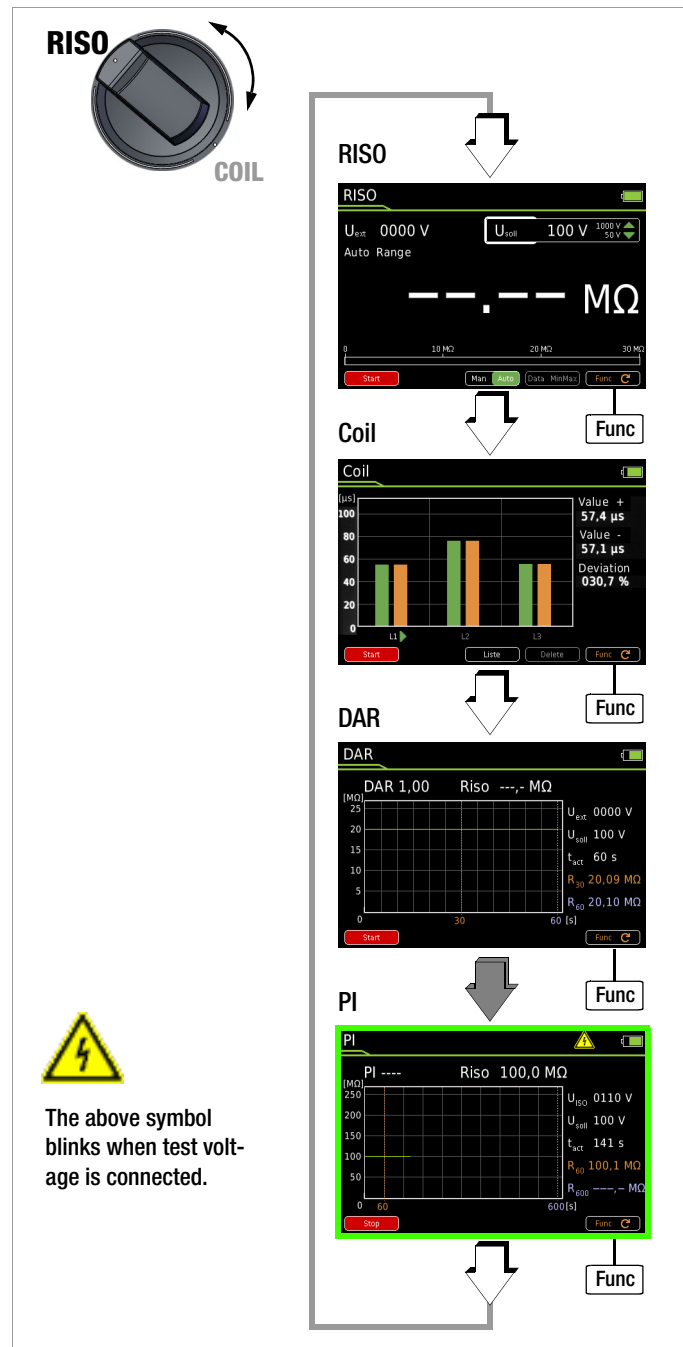
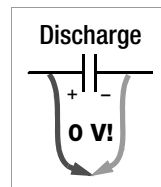

6.6 Voltage Measurement

Notes Regarding Voltage Measurement

- **The multimeter may only be operated with installed rechargeable batteries or mains module. Dangerous voltages are otherwise not indicated, and the instrument may be damaged.**
- The multimeter may only be operated by persons who are capable of recognizing **touch hazards** and taking the appropriate safety precautions. Contact hazards exist anywhere, where voltages of greater than 33 V (RMS) may occur. The test probes may only be gripped up to the finger guard. Do not touch the metallic test probes under any circumstances.
- Avoid working alone when taking measurements which involve **touch hazards**. Be certain that a second person is present.
- **Maximum permissible voltage** between the V and \perp (ground) terminals is 1000 V for measuring category III and 600 V for measuring category IV.
- Be prepared for the occurrence of unexpected voltages at devices under test (e.g. defective devices). For example, capacitors may be dangerously charged.
- No measurements may be made with this instrument in electrical circuits with corona discharge (high-voltage).
- Special care is required when measurements are made in HF electrical circuits. Dangerous pulsating voltages may be present.
- **Be aware of the fact that dangerous voltage spikes are not displayed during measurement with the low-pass filter.**
We recommend measuring voltage without the low-pass filter first, in order to be able to detect any dangerous voltages.
- Be absolutely certain that the measuring ranges are not overloaded beyond their allowable capacities. Limit values are included in chapter 8, "Characteristic Values", in the table entitled "Measuring Functions and Measuring Ranges" in the "Overload Capacity" column.



Note

Rotary selector switch position "**RISO**" is available for the detection of interference voltage during insulation resistance measurement.

Use switch position $V \sim$, $V \equiv$ or $V \approx$ in order to perform precise voltage measurements.

6.6.1 Alternating Voltage and Frequency Measurement V AC and Hz with Selectable Low-Pass Filter

- In accordance with the voltage or frequency to be measured, turn the rotary switch to V~ or Hz.
- Press the **MENU** key.
- Press the “Setup for currently selected measurement” softkey.
- Make sure that the **Clip** parameter is set to **Off**. Otherwise all measured values are displayed in amperes, corrected by the amount resulting from the selected transformation ratio for an interconnected current clamp sensor.
- The display is returned to the measurement view by pressing the **ESC** key twice.
- Repeatedly press the **Func** softkey until the desired measuring function is displayed.
- Connect the measurement cables as shown. The “L” connector jack should be grounded.

V AC – Voltage Measurement

Note
An intermittent acoustic signal warns the operator if the measured value exceeds the upper range limit in the 1000 V range.

Make sure that a current measuring range (“A”) has not been activated, when the multimeter is connected for voltage measurement! If the fuse’s blowing limits are exceeded as a result of operator error, both the operator and the instrument are in danger!

- You can switch back and forth between voltage measurement with and without low-pass filter.
- Repeatedly press the **Func** softkey until the unit of measure **VAC** or **VAC Fil** appears at the display.
- If necessary, conduct zero balancing by pressing the **Zero** key (see chapter 6.6.4 for description).

Hz – Frequency Measurement

- Connect the measured quantity in the same way as for voltage measurement.
- Manually select the measuring range for the voltage amplitude. When the instrument is switched to frequency measurement, the previously selected voltage measuring range remains active.
- Repeatedly press the **Func** softkey until the unit of measure **Hz** appears at the display. Lowest measurable frequencies and maximum allowable voltages are listed in chapter 8, “Characteristic Values”,.

VAC Fil – Voltage Measurement with Low-Pass Filter

Attention!
Be aware of the fact that dangerous voltage spikes are not displayed during this type of measurement (see also “Voltage Comparator”).
We recommend measuring voltage without the low-pass filter first, in order to be able to detect any dangerous voltages.

A 1 kHz/-3dB low-pass filter can be activated if required, in order to filter out capacitively induced high frequency pulses of greater than 1 kHz, for example when performing measurements at cables, i.e. undesired voltages of greater than 1 kHz can be suppressed.

Fil appears at the display in order to indicate the activated low-pass filter. The multimeter is automatically switched to manual measuring range selection.

Specified measuring accuracy is not reached with signals of greater than 500 Hz when the filter is active.

The diagram illustrates the multimeter's operation for AC voltage and frequency measurement. It shows the rotary switch with positions for V~ and Hz, and a schematic of the internal circuitry including a transformer (VCO), temperature sensor (Temp), coil (COIL), and a 1/4 mΩ resistor. A sequence of five LCD screens shows the measurement process: 1. VAC (Auto Range) displaying 232,46 V. 2. Hz (Auto Range) displaying 050,00 Hz. 3. Duty AC displaying 050,5 %. 4. RPM AC (Engine 4-S) displaying 06000 RPM. 5. VAC Fil (Manual Range 300 V) displaying 233,62 V. Navigation arrows and 'Zero'/'Func' buttons are shown between screens.

Measuring ranges:
V: 300 mV/3 V/30 V/
V: 300 V/1000 V
Hz: 300 Hz/3 kHz/
Hz: 30 kHz/300 kHz

Max. 1000 V 3 kHz
Hz: 1 Hz ... 300 kHz
 $P_{max} = 3 \times 10^6 \text{ V} \times \text{Hz}$

V~ & Filter

Voltage Comparator for Displaying Dangerous Voltage

The input signal or measuring signal is checked by a voltage comparator for dangerous spikes, because these do not appear at the display when the low-pass filter is used.

At voltages of greater than 15 V AC or 25 V DC, a danger symbol appears at the display: ⚠

Note
The “Setup for currently selected measurement” sub-menu cannot be accessed for the above described measurements because no further settings are provided for.

6.6.2 Duty Cycle Measurement – Duty AC

The pulse-period ratio can be ascertained for square-wave signals with the duty cycle measurement.

- Set the rotary switch to V~.
- Repeatedly press the **Func** softkey until **Duty AC** appears at the display.
- Connect the measurement cables as you would for a voltage measurement.

Make sure that a current measuring range (“A”) has not been activated, when the multimeter is connected for frequency or duty cycle measurement!

The ratio of pulse duration to pulse period is measured with periodic square-wave signals and is displayed as a percentage.

$$\text{Duty cycle (\%)} = \frac{\text{Pulse duration (t}_E\text{)}}{\text{Pulse period (t}_P\text{)}} \cdot 100$$



Note

The applied frequency must remain constant during duty cycle measurement.

6.6.3 RPM Measurement – RPM AC

Revolutions per minute at 2 and 4-stroke internal combustion engines (also known as rotational frequency) are measured by acquiring pulses. The number of measurable pulses per revolution varies depending upon engine type (2 or 4 stroke). As a prerequisite for this measurement, the number of measurable pulses per revolution must first be set in the RPM settings menu (RPM ≠ OFF) (see below).

- Set the rotary switch to V~.
- Repeatedly press the **Func** softkey until **RPM AC** appears at the display.
- Select the desired motor **2-S** or **4-S** via the scroll keys ▲▼.
- Connect the measurement cables as you would for a voltage measurement. In the case of internal combustion engines, ignition pulses can be acquired alternatively with a current sensor (see wiring diagram).
- The measured value then appears in RPM, for example “244.3 r”.

$$\text{RPM} = \left(\frac{\text{Revolutions}}{\text{min}} \cdot \frac{\text{Pulses}}{\text{Revolution}} \right) \times \frac{60\text{s}}{\text{s}}$$

Measured RPM value revolutions per minute

RPM parameter pulses per revolution

Pulses per Revolution Settings Menu

- 2-S RPM measurement at 2-stroke engines: 1 pulse per revolution) or
- 4-S RPM measurement at 4-stroke engines: 1 pulse per 2 revolutions)

Voltage Comparator for Displaying Dangerous Voltage

The input signal or measuring signal is checked by a voltage comparator for dangerous spikes, because these do not appear at the display when the low-pass filter is used.

At voltages of greater than 15 V AC or 25 V DC, a danger symbol appears at the display:

V~
Hz

Measuring ranges:
Duty AC: 2.0 ... 98.0%

Duty AC measuring ranges:

MR	Hz	t _E /t _P
3 V	15 Hz ... 1 kHz	2 ... 98%
	1 kHz ... 4 kHz	10 ... 90%
30 V	15 Hz ... 1 kHz	5 ... 95%
	1 kHz ... 4 kHz	10 ... 90%

Max. 1000 V 3 kHz
Hz: 1 Hz ... 300 kHz
P_{max} = 3 x 10⁶ V x Hz

Pulse Time Quantities

- f_P pulse frequency = 1/t_P
- t_E pulse duration
- t_P pulse period
- t_P - t_E interpulse period
- t_E/t_P pulse or duty cycle

Measuring ranges:
RPM: 30 ... 30,000

Max. 1000 V 3 kHz
Hz: 1 Hz ... 300 kHz
P_{max} = 3 x 10⁶ V x Hz

6.6.4 Direct and Pulsating Voltage Measurement, V DC and V (AC+DC)

- Set the rotary switch to V $\overline{=}$ or V $\overline{\approx}$.
- Press the **MENU** key.
- Press the “Setup for currently selected measurement” softkey.
- Make sure that the **Clip** parameter is set to **Off**. Otherwise all measured values are displayed in amperes, corrected by the amount resulting from the selected transformation ratio for an interconnected current clamp sensor.
- The display is returned to the measurement view by pressing the **ESC** key twice.
- Repeatedly press the **Func** softkey until the desired measuring function is displayed.
- If necessary, conduct zero balancing by pressing the **Zero** key (see description below).
- Connect the measurement cables as shown. The “1” connector jack should be grounded.
- Measurement is started immediately.

Note
V (AC+DC) measurement: Due to system design, the DC component displayed in the smallest measuring range (300 mV) has an offset. Select the VDC function for precise measurement of the DC component.

Note
 An intermittent acoustic signal warns the operator if the measured value exceeds the upper range limit in the 1000 V range.

Make sure that a current measuring range (“A”) has **not** been activated, when the multimeter is connected for voltage measurement! If the fuse’s blowing limits are exceeded as a result of operator error, both the operator and the instrument are in danger!

As soon as the **Man / Auto** key is pressed, and assuming the measured value is less than 280 mV, the multimeter is switched to the mV measuring range.

V (AC+DC) Fil – Measurement with Low-Pass filter

Attention!
 Be aware of the fact that dangerous voltage spikes are not displayed during this type of measurement (see also “Voltage Comparator”).
 We recommend measuring voltage without the low-pass filter first, in order to be able to detect any dangerous voltages.

A 1 kHz/-3dB low-pass filter can be activated if required, in order to filter out capacitively induced high frequency pulses of greater than 1 kHz, for example when performing measurements at cables, i.e. undesired voltages of greater than 1 kHz can be suppressed.

Fil appears at the display in order to indicate the respectively activated low-pass filter. The multimeter is automatically switched to manual measuring range selection.

Specified measuring accuracy is not reached with signals of greater than 500 Hz when the filter is active.

The diagram illustrates the connection of a multimeter to a circuit and the resulting display screens for different voltage measurement functions. The circuit includes a switch (S), a temperature sensor (Temp), a coil (COIL), and a milliohm (mΩ/4) resistor. The multimeter is connected to the circuit terminals.

Measuring ranges:
 300 mV/3 V/30 V/
 300 V/1000 V

Max. 1000 V 3 kHz
 $P_{max} = 3 \times 10^6 \text{ V} \times \text{Hz}$

The display screens show the following measurements:

- VDC:** Auto Range, 15,000 v
- V AC/DC:** Auto Range, 15,025 v
- V (AC+DC) Fil:** Manual Range 30 V, 15,026 v

Navigation keys shown: Zero, Man, Auto, Data MinMax, Func.

Voltage Comparator for Displaying Dangerous Voltage

The input signal or measuring signal is checked by a voltage comparator for dangerous spikes, because these do not appear at the display when the low-pass filter is used.

At voltages of greater than 15 V AC or 25 V DC, a danger symbol appears at the display: ⚠

Improving Accuracy by means of Zero Balancing – Zero

The currently measured voltage value can be subtracted from future measurements in all voltage measuring ranges.

- Press the **Zero** softkey.
- The value ascertained for **Zero** is saved and appears above the measurement display. Automatic compensation is implemented for future measurements. This value remains in memory even after the instrument has been switched off.
- The value for Zero is retained when the instrument is switched to a different measuring function. The correction or offset value is deleted by pressing **Zero** once again, or when the instrument is switched off. The value is cleared from the display.

6.7 Resistance Measurement “Ω”

- ⇨ Disconnect supply power from the electrical circuit of the device to be measured, and discharge all high-voltage capacitors.
- ⇨ Make sure that the device under test is voltage-free. Interference voltages distort measurement results! Refer to Chapter 6.6.4 regarding testing for the absence of voltage with the help of the direct voltage measurement.
- ⇨ Set the rotary switch to “Ω”.
- ⇨ Repeatedly press the **Func** softkey until the “Ω” measuring function is displayed.
- ⇨ If necessary, conduct zero balancing by pressing the **Zero** key (see description below).
- ⇨ Connect the device under test as shown.
- ⇨ Measurement is started immediately.



Note

Use short or shielded measurement cables in the case of high-impedance resistance.

Improving Accuracy by means of Zero Balancing – Zero

Cable resistance and contact resistance can be eliminated in all measuring ranges by means of zero balancing.

- ⇨ Short circuit the measurement cables to this end.
- ⇨ Press the **Zero** softkey.
- ⇨ Insofar as the value for **Zero** is less than a permissible threshold of 0 to 50% of the measuring range, the **Zero** softkey is no longer grayed out in the display and the **Zero** function can be activated by pressing the **Zero** key.
- ⇨ The value ascertained for **Zero** is saved and appears above the measurement display. Automatic compensation of cable resistance is activated for all subsequent measurements.
- ⇨ The value for Zero is retained when the instrument is switched to a different measuring function. The correction or offset value is deleted by pressing **Zero** once again, or when the instrument is switched off. The value is cleared from the display.



Note

The “Setup for currently selected measurement” sub-menu cannot be accessed for the resistance measurement because no further settings are provided for.

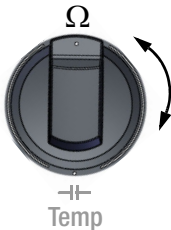

Temp

Measuring ranges:
300 Ω/3 kΩ/30 kΩ/
300 kΩ/3 MΩ/30 MΩ

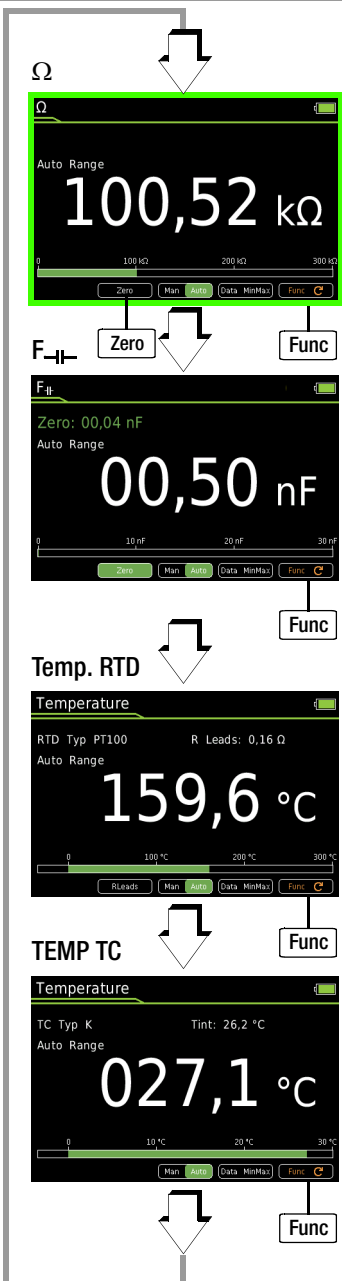

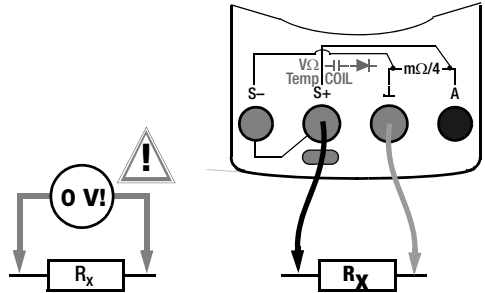

6.8 Capacitance Measurement F \rightarrow C

- Disconnect supply power from the electrical circuit of the device to be measured, and discharge all high-voltage capacitors.
- Make sure that the device under test is voltage-free. Capacitors must always be discharged before measurement is performed. Interference voltages distort measurement results! Refer to Chapter 6.6.4 regarding testing for the absence of voltage with the help of the direct voltage measurement.
- Set the rotary switch to “ Ω ” or \rightarrow C.
- Repeatedly press the **Func** softkey until the F \rightarrow C measuring function is displayed.
- If necessary, conduct zero balancing by pressing the **Zero** key (see description below).
- Connect the (discharged!) device under test to the sockets with the measurement cables as shown.
- Measurement is started immediately.

Improving Accuracy by means of Zero Balancing – Zero

Cable capacitance and junction capacitance can be eliminated in all measuring ranges by means of zero balancing.

- Open the connected measurement cables to this end.
- Press the **Zero** softkey.
- Insofar as the value for **Zero** is less than a permissible threshold of 0 to 50% of the measuring range, the **Zero** softkey is no longer grayed out in the display and the **Zero** function can be activated by pressing the **Zero** key.
- The value ascertained for **Zero** is saved and appears above the measurement display. Automatic compensation of cable capacitance is activated for all subsequent measurements. This value remains in memory even after the instrument has been switched off.
- The value for Zero is retained when the instrument is switched to a different measuring function. The correction or offset value is deleted by pressing **Zero** once again, or when the instrument is switched off. The value is cleared from the display.



Note

The “-” pole of polarized capacitors must be connected to the “ \perp ” jack. Resistors and semiconductor paths connected in parallel to the capacitor distort measurement results!



Note

The “Setup for currently selected measurement” sub-menu cannot be accessed for the capacitance measurement because no further settings are provided for.

Measuring ranges:
30 nF/300 nF/
3 μ F/30 μ F/300 μ F

6.9 Temperature Measurement with Resistance Thermometer – Temp RTD

Temperature measurement is performed with a Pt100 or Pt1000 resistance thermometer (accessory, not included), which is connected to the voltage input.

- Set the rotary switch to “Ω” or “Temp”.
- Repeatedly press the **Func** softkey until the **Temp RTD** measuring function is displayed.
- Select the connected temperature sensor (see settings menu below).
- Ascertain offset resistance by pressing the **R Leads** softkey or, if the value is known, enter it to the “Setup for currently selected measurement” submenu (see below). The currently selected value for R Leads appears above the measurement display.
- Connect the sensor to the sockets with the measurement cables as shown.
- Measurement is started immediately. The instrument displays the measured temperature using the selected unit of measure.

Temperature Sensor Selection

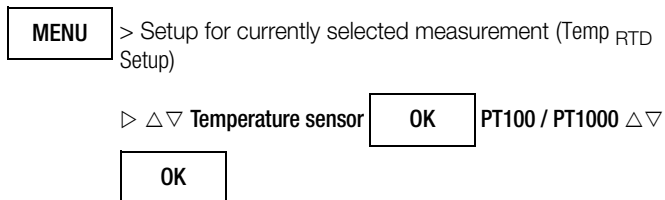

Selecting the Unit of Measure for Temperature

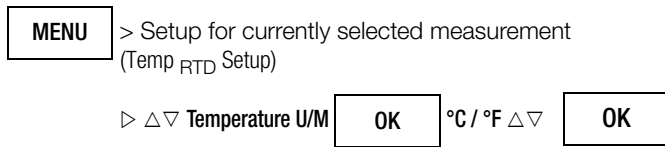

(°C = default setting)

Entering R Leads Offset Resistance

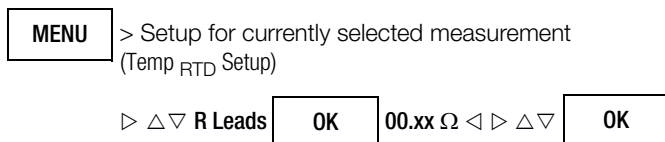

- Enter the known resistance of the connector cables with the scroll keys:
Select the digit to be changed with the ◀ ▶ keys, and change the respectively selected digit with the ∇ Δ keys. The default value is 0.43 Ω. Values can be selected within a range of 0 to 50 Ω.

Ascertaining Cable Resistance – R Leads

- Press the **RLeads** softkey. The “Short circuit cable!” message appears.
- Short circuit the connected measurement cables.
- Store the measured offset resistance value by pressing the **Save** softkey. The ascertained value for R Leads appears above the measurement display. Automatic compensation of cable resistance is activated for all subsequent measurements. Cable resistance remains in memory even after the instrument has been switched off.

Measuring Ranges

RTD	Pt100	-200.0 ... +850.0 °C
RTD	Pt1000	-150.0 ... +850.0 °C

6.10 Temperature Measurement with Thermocouple – Temp TC

Temperature measurement is performed with a type K thermocouple (accessory, not included), which is connected to the voltage input.

- Set the rotary switch to “Ω” or “Temp”.
- Repeatedly press the **Func** softkey until the **Temp TC** measuring function is displayed.

The reference temperature is measured via an internal reference junction. It's displayed as TINT, or it can be queried via “General Setup” (see description below).

The “Setup for currently selected measurement” menu can be used to specify whether or not the internal reference junction temperature or a manually entered temperature will be used (see below). If “Manual” temperature is selected, TMAN appears that the display.

- Connect the sensor to the sockets with the measurement cables as shown.
- Measurement is started immediately. The instrument displays the measured temperature using the selected unit of measure.

Querying the Measured Reference Temperature

MENU > General Setup > Info > **Temperature xx.x °C**



Note

The internal reference temperature (temperature of the internal reference junction) is measured by a temperature sensor inside the instrument. This may be somewhat higher or lower than room temperature as a result of internal heat-up, or moving from warmer to colder surroundings or vice versa.

Selecting the Unit of Measure for Temperature

MENU > Setup for currently selected measurement (Temp TC Setup)

▷ Δ▽ **Temperature U/M** **OK** °C / °F Δ▽ **OK**

(°C = default setting)

Entering “Manual” Reference Temperature Tman

MENU > Setup for currently selected measurement (Temp TC Setup)

▷ Δ▽ **Tman** **OK** +xx.x °C ◀▷ Δ▽ **OK**

Choice Between Measured and “Manual” Reference Temperature

MENU > Setup for currently selected measurement (Temp TC Setup)

▷ Δ▽ **Compensation Type** **OK** Man / Int Δ▽

OK

Man Manually specified reference temperature

Int Internally measured reference temperature

Measuring Range

TC	K (NiCr-Ni)	-250.0 ... +1372.0 °C
----	-------------	-----------------------

6.11 Continuity Test Ω

- Disconnect supply power from the electrical circuit of the device to be measured, and discharge all high-voltage capacitors.
- Make sure that the device under test is voltage-free. Interference voltages distort measurement results!
- Set the rotary switch to “ Ω ”.
- A loudspeaker symbol appears at the display.
- Select the desired threshold with the $\blacktriangle/\blacktriangledown$ scroll keys (see description below).
- Connect the conductor path under test as shown.
- Measurement is started immediately.

Adjusting the Threshold

Depending upon the selected threshold, the multimeter generates a continuous acoustic signal in the case of continuity or short-circuiting, i.e. at a value of less than the selected threshold.

“OL” appears at the display in the case of an open connection.

The threshold is adjusted with the $\blacktriangle/\blacktriangledown$ scroll keys.

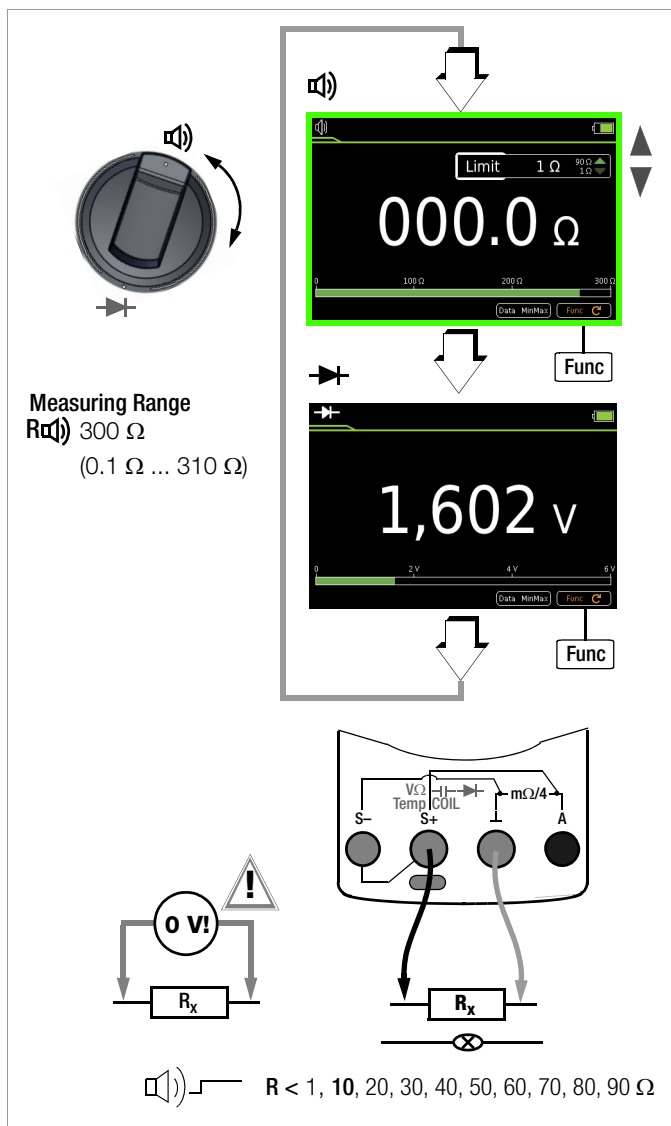

Note

The “Setup for currently selected measurement” sub-menu cannot be accessed for the continuity test or the diode test.

6.12 Diode Testing \rightarrow with Constant Current of 1 mA

- Disconnect supply power from the electrical circuit of the device to be measured, and discharge all high-voltage capacitors.
- Make sure that the device under test is voltage-free. Interference voltages distort measurement results! Refer to Chapter 6.6.4 regarding testing for the absence of voltage with the help of the direct voltage measurement.
- Set the rotary switch to “ Ω ”.
- Press the **Func** key.
- The diode symbol appears at the display.
- Connect the device under test as shown.
- Measurement is started immediately.

Forward Direction and Short-Circuit

The instrument displays forward voltage in volts (display: 4 places). As long as voltage drop does not exceed the maximum display value of 5.1 V, several series connected components or reference diodes with small reference voltages, as well as Zener diodes and LEDs, can be tested.

Reverse Direction and Interruption

The measuring instrument indicates overflow “OL”.



Note

Resistors and semiconductor paths connected in parallel to the diode distort measurement results!

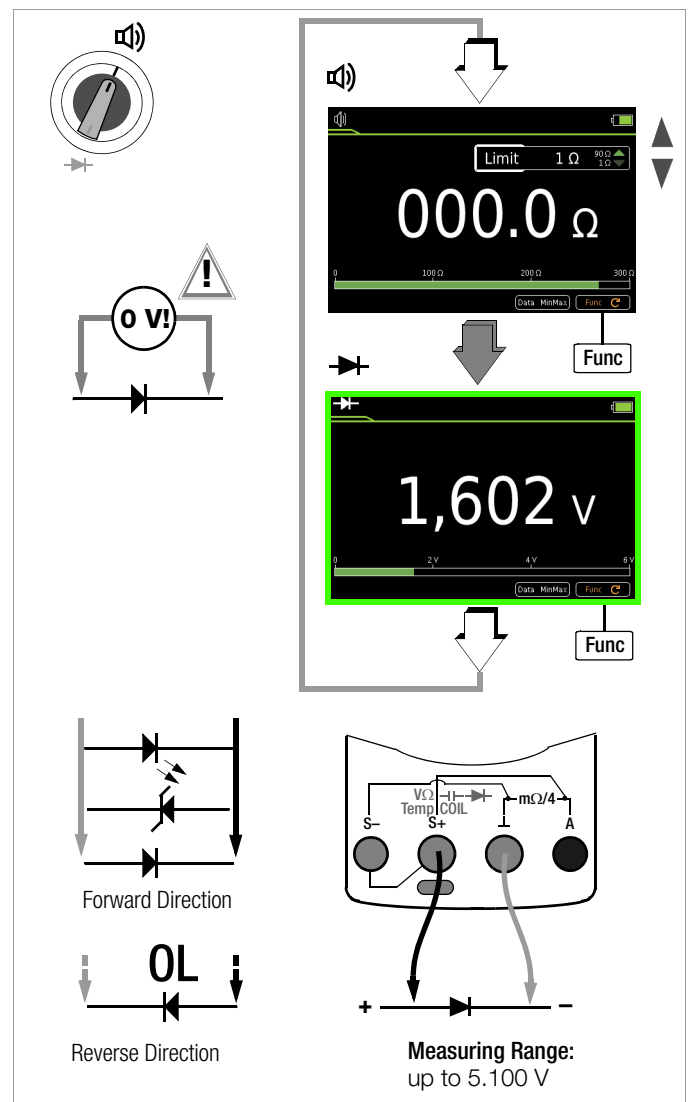

6.13 Milliohm Measurement – Rlo (2-wire measurement)

- ❖ Disconnect supply power from the electrical circuit of the device to be measured, and discharge all high-voltage capacitors.
- ❖ Make sure that the device under test is voltage-free. Interference voltages distort measurement results! Refer to Chapter 6.6.4 regarding testing for the absence of voltage with the help of the direct voltage measurement.
- ❖ Set the rotary switch to **Rlo**.
- ❖ Select desired test current **I_{p set}** with the ▲▼ scroll keys.
- ❖ Select desired test current **I_{p set}** polarity: ±/+/–
- ❖ Connect the device under test as shown.
- ❖ Activate the measurement by pressing the **Start** softkey on the instrument or on the included probe.
- ❖ If necessary, conduct zero balancing by pressing the **Zero** key (see description below).
- ❖ Press the **Stop** softkey in order to end the measurement.

Improving Accuracy by means of Zero Balancing – Zero

Cable resistance and contact resistance can be eliminated in all measuring ranges by means of zero balancing.

- ❖ Short circuit the measurement cables to this end.
- ❖ Activate the measurement by pressing the **Start** softkey.
- ❖ Insofar as the value for **Zero** is less than a permissible threshold of 0 to 50% of the measuring range, the **Zero** softkey is no longer grayed out in the display and the **Zero** function can be activated by pressing the **Zero** key.
- ❖ The value ascertained for **Zero** is saved and appears above the measurement display. Automatic compensation of cable resistance is activated for all subsequent measurements. Cable resistance is deleted after the measurement has been ended.
- ❖ The correction or offset value is deleted by pressing **Zero** once again during measurement, or by ending the measurement. The value is cleared from the display.



Note

The “Setup for currently selected measurement” submenu cannot be accessed for the milliohm measurement, because zero balancing and the polarity of the test current I_p can be selected directly in the measurement view.

Blown Fuse

In the event of a blown fuse, measurement is not possible and the following display appears:

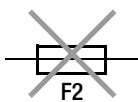

Rlo

Measuring ranges:
300 mΩ/3 Ω/30 Ω

Test current:
±/+/– 20 mA
±/+/– 200 mA

Start

Zero

Zero

Stop

Short circuit measuring cable ends

6.14 Milliohm Measurement – $m\Omega/4$ (4-wire measurement)

6.14.1 Compensation of Cable Resistance

Electrical resistance is a dipole which can generally only be measured using two poles. This is accomplished by directing a measuring current of predetermined magnitude through the device under test and measuring the resultant voltage drop. The respective resistance value is derived from the quotient of these two values.

The two points between which voltage is measured are decisive as regards the results of the measurement. All resistances between these two points add to the measured resistance value. These include contact resistance, as well as cable resistance. If a very low resistance value needs to be measured, for example contact resistance at a contactor with a value of only a few milliohms, the points between which voltage is measured must be moved out of the measuring instrument and positioned as closely as possible to the device under test. For this reason, the measuring instrument is equipped with separate jacks for current feed and voltage measurement. This type of 4-pole connection is known as connection according to Kelvin.

KC4 Kelvin clips and KC27 Kelvin probes (available as accessories) allow for simple, correct connection.

Measurement with the KC27 Kelvin Probe

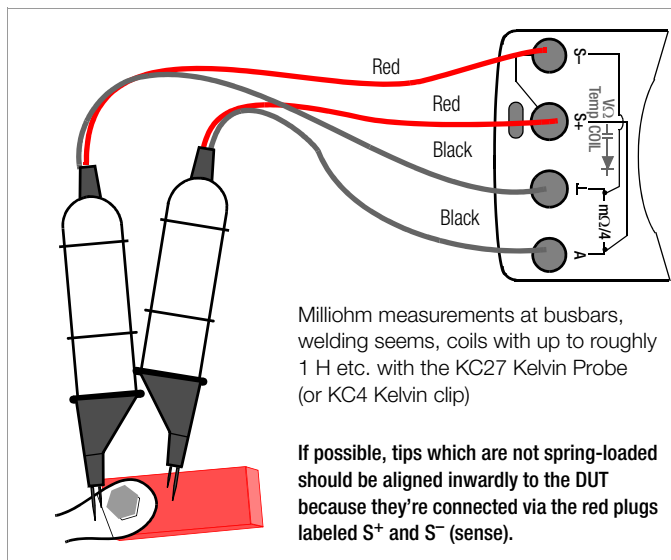

6.14.2 Thermovoltage Compensation

Thermovoltages which occur as a result of material and temperature differences may distort measurement results. For this reason, the instrument is equipped with automatic thermal voltage compensation within the relevant ranges.

Measuring ranges:
300 m Ω /3 Ω /30 Ω

Test current:
+20 mA/+200 mA/+2 A

Overall measuring range:
m Ω : 0.001 m Ω ... 30 Ω

Note:
If KC27 or KC4 is used, the red plug is always connected to S+ or S-.



Note

If measuring current is interrupted during the 4-L-m Ω measurement, or if the fuse blows, “LEADS OPEN” blinks at the display. Refer to chapter 9.3 in the event of a blown fuse.

6.14.3 Milliohm Measurement with 200 mA or 20 mA DC [mΩ]

- ⇒ Make sure that the device under test is voltage-free (see Chapter 6.6.4). Interference voltages distort measurement results!
- ⇒ Set the rotary switch to “mΩ/4”.
- ⇒ Select desired test current **Ip set** with the ▲▼ scroll keys.
- ⇒ If applicable, select the desired measuring range using the **Man / Auto** key: **30 mΩ**, **300 mΩ**, **3 Ω** (Ip set = +200 mA) or **30 Ω** (Ip set = +20mA).
- ⇒ Connect the device under test as shown.
- ⇒ Activate the measurement by pressing the **Start** softkey.
- ⇒ If required, activate thermovoltage correction (see description below).
- ⇒ Press the **Stop** softkey in order to end the measurement.

KC4 Kelvin clips and KC27 Kelvin probes (available as accessories) allow for simple, correct connection.

Resistance at the current jacks should amount to < 5 Ω.

This measuring method is suitable for resistances with inductances of up to 1 H.

Thermovoltage Correction in the 30/300 mΩ Range

- ⇒ Connect the measurement cables and press the **TComp** softkey in order to measure thermovoltage. Wait until the measured value has settled in. This may take several seconds, depending upon inductivity. After the measured value has settled in, press the **Save** softkey. The **TComp** softkey changes color from black to green. All future measurement results will be corrected based upon the previously measured thermovoltage value. Thermovoltage can also be measured during a running measurement after pressing the Start softkey. Use the same procedure as described above.

Measurements at Inductive Devices

Coils, for example in motors, choke ballasts and contactors, are highly inductive. Changes in current at inductive devices, including those caused by switching the milliohmmeter on and off or changing the measuring range, result in a corresponding voltage change. These changes may be of significant magnitude, and may result in arcing under unfavorable conditions. The milliohmmeter is protected against arcing by means of suitable voltage arrestors.

6.14.4 Milliohm Measurement with 1 A Pulsating Measuring Current (automatic thermovoltage correction at 3 ... 300 mΩ)

- ⇒ Make sure that the device under test is voltage-free (see Chapter 6.6.4). Interference voltages distort measurement results!
- ⇒ Set the rotary switch to “mΩ/4”.
- ⇒ Connect the device under test as shown. KC4 Kelvin clips and KC27 Kelvin probes (available as accessories) allow for simple, correct connection. Resistance at the current jacks should amount to < 0.5 Ω.
- ⇒ If applicable, select the desired measuring range using the **Man / Auto** key: **3 mΩ** (Ip set = +1A), **(30 mΩ or 300 mΩ)** (Ip set = +1A)
- ⇒ Connect the device under test as shown. Thermovoltage is compensated automatically.
- ⇒ Activate the measurement by pressing the **Start** softkey.
- ⇒ Press the **Stop** softkey in order to end the measurement.

The 1 A setting for test current can be protected with a password. If applicable, you'll be prompted to enter the valid password.

See also chapter 4.4.6 on page 10, “Changing the Password”, and chapter 6.1 on page 20, “Enabling Parameter Changes”.

Thermovoltage Correction in the 30/300 mΩ Range

- ⇒ First of all press the **Start** softkey and then the **TComp** softkey in order to measure thermovoltage. The **TComp** softkey changes color from black to green. Wait until the measured value has settled in. This may take several seconds, depending upon inductivity. All future measurement results will be corrected based upon the previously measured thermovoltage value.

6.15 Current Measurement

Notes Regarding Current Measurement

- **The multimeter may only be operated with installed rechargeable battery pack or mains module. Dangerous currents are otherwise not indicated, and the instrument may be damaged.**
- Set up the measuring circuit in a mechanically secure fashion, and secure it against inadvertent breaks. Select conductor cross-sections and lay out connections such that they do not overheat.
- In the case of current greater than 1.1 A, “**OL**” appears at the display.
- The input for the current measuring range is equipped with a fuse link. Maximum permissible voltage for the measuring circuit (= rated voltage of the fuse) is 1000 V AC/DC. Use specified fuses only! The fuse must have a **breaking capacity of at least 30 kA**.
- If the fuse for the active measuring range has blown, the blown fuse symbol appears at the digital display.
- If a fuse should blow, eliminate the cause of overload before placing the instrument back into service!
- Fuse replacement is described in Chapter 9.3.
- Be absolutely certain that the measuring ranges are not overloaded beyond their allowable capacities. Limit values are included in chapter 8, “Characteristic Values”, in the table entitled “Measuring Functions and Measuring Ranges” in the “Overload Capacity” column.

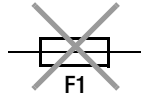

6.15.1 Direct and Pulsating Current Measurement, Direct Connection, – A DC and A (AC+DC)

- ⇒ First disconnect supply power from the measuring circuit or the power consumer (1), and discharge any capacitors.
- ⇒ Set the rotary switch to A \approx (A \approx).
- ⇒ Repeatedly press the **Func** softkey until the desired measuring function is displayed.
- ⇒ If necessary, conduct zero balancing by pressing the **Zero** softkey (see description below).
- ⇒ Safely connect the measuring instrument (without contact resistance) in series to the power consumer (2) as shown.
- ⇒ Switch supply power to the measuring circuit back on (3).
- ⇒ Read the display. Make a note of the measured value if the instrument is not being operated in the memory mode or the transmission mode.
- ⇒ Disconnect supply power from the measuring circuit or the power consumer (1) once again, and discharge any capacitors.
- ⇒ Remove the test probes from the measuring point and return the measuring circuit to its normal condition.

Improving Accuracy by means of Zero Balancing – Zero

The currently measured current value can be subtracted from future measurements in all measuring ranges.

- ⇒ Press the **Zero** softkey.
- ⇒ The value ascertained for **Zero** is saved and appears above the measurement display. Automatic compensation is implemented for future measurements.
- ⇒ The value for Zero is retained when the instrument is switched to a different measuring function. The correction or offset value is deleted by pressing **Zero** once again, or when the instrument is switched off. The value is cleared from the display.

A DC Measuring Range:
A \approx : 10 nA ... 1 A

5 ranges:
300 μ A / 3 mA / 30 mA / 300 mA / 1 A

A (AC+DC) measuring range:
A \approx : 10 nA ... 1 A

5 ranges:
300 μ A / 3 mA / 30 mA / 300 mA / 1 A

The diagram illustrates the following steps:

- Initial measurement in **A DC** mode shows 23,979 mA.
- Pressing **Zero** and **Func** switches to **A (AC+DC)** mode, showing 23,988 mA.
- Pressing **Zero** and **Func** switches to **AAC** mode, showing 000,00 μ A.
- Pressing **Func** switches to **Hz** mode, showing 000,00 Hz.

The circuit diagram at the bottom shows a power source connected to a resistor R_x . The measuring instrument is connected in series with the resistor to measure the current. The instrument's internal circuitry includes a switch (S), a coil (COIL), and a diode (mC2/4).

6.15.2 Alternating Current and Frequency Measurement, Direct Connection, – AAC and Hz

- ⇨ First disconnect supply power from the measuring circuit or the power consumer (1), and discharge any capacitors.
- ⇨ Set the rotary switch to A $\overline{=}$ (A $\overline{=}$).
- ⇨ Repeatedly press the **Func** softkey until the desired measuring function is displayed.
- ⇨ If necessary, conduct zero balancing for **AAC** by pressing the **Zero** softkey (see description below).
- ⇨ Safely connect the measuring instrument (without contact resistance) in series to the power consumer as shown.
- ⇨ Switch supply power to the measuring circuit back on (3).
- ⇨ Read the display. Make a note of the measured value if the instrument is not being operated in the memory mode or the transmission mode.
- ⇨ Disconnect supply power from the measuring circuit or the power consumer (1) once again, and discharge any capacitors.
- ⇨ Remove the test probes from the measuring point and return the measuring circuit to its normal condition.

Improving Accuracy by means of Zero Balancing – Zero

The currently measured current value can be subtracted from future measurements in all measuring ranges.

- ⇨ Press the **Zero** softkey.
- ⇨ The value ascertained for **Zero** is saved and appears above the measurement display. Automatic compensation is implemented for future measurements.
- ⇨ The value for Zero is retained when the instrument is switched to a different measuring function. The correction or offset value is deleted by pressing **Zero** once again, or when the instrument is switched off. The value is cleared from the display.

A AC measuring range:
A~: 10 nA ... 1 A

5 ranges:
300 μ A / 3 mA / 30 mA / 300 mA / 1 A

Hz measuring range:
Hz: 0.01 ... 300 kHz

4 ranges:
300 Hz / 3 kHz / 30 kHz / 300 kHz

AAC

Hz

Warning: $I > 1 A$

6.15.3 Direct and Pulsating Current Measurement with Current Clamp Sensor – ADC and A (AC+DC)

Voltage/Current Transformer Output

When a current clamp sensor is connected to the multimeter (V input), all current displays appear with the correct value in accordance with the selected transformation ratio. The only prerequisite is that the current sensor is equipped with at least one of the below listed transformation ratios, and that the ratio has been previously selected in the following menu (**Clip** ≠ **Off**).

- Set the rotary switch to $V \overline{=}$ or $V \overline{=}$.
- Press the **MENU** key.
- Press the “Setup for currently selected measurement” softkey.
- Set the **Clip** parameter to the desired transformation ratio (the same ratio as selected at the current clamp sensor) as described below in the current clamp settings menu or select the desired transformation ratio with the scroll keys $\blacktriangle/\blacktriangledown$.
- The display is returned to the measurement view by pressing the **ESC** key three times.
- Repeatedly press the **Func** softkey until the desired measuring function is displayed.
- Connect the current clamp sensor’s measurement cables as shown.
- If necessary, conduct zero balancing by pressing the **Zero** key (see description below).

Current Clamp Setup Menu

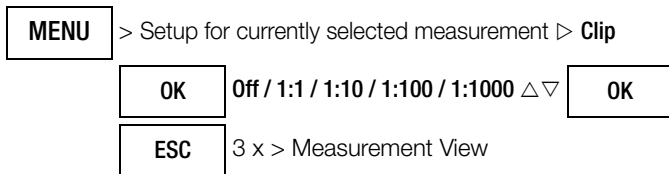

Transformation Ratio	Measuring Ranges			Clamp Type
	300 mV	3 V	30 V	
1:1 1mV/1mA	300.0 mA	3.000 A	30.00 A	
1:10 AM 1mV/10mA	3.000 A	30.00 A	300.0 A	CP30
1:100 1mV/100mA	30.00 A	300.0 A	3,000 kA	CP330/1100/ 1800
1:1000 1mV/1A	300.0 A	3,000 kA	30.00 kA	CP330/1100/ 1800

The maximum allowable operating voltage is equal to the nominal voltage of the current transformer. When reading the measured value, additional error resulting from the current clamp sensor must also be taken into consideration (default setting: **Clip** = **Off** = voltage display).

Improving Accuracy by means of Zero Balancing – Zero

The currently measured current value can be subtracted from future measurements in all measuring ranges.

- Press the **Zero** softkey.
- The value ascertained for **Zero** is saved and appears above the measurement display. Automatic compensation is implemented for future measurements.
- The correction or offset value is deleted by pressing **Zero**, by changing to another measuring function or by switching the instrument off. The value is cleared from the display.

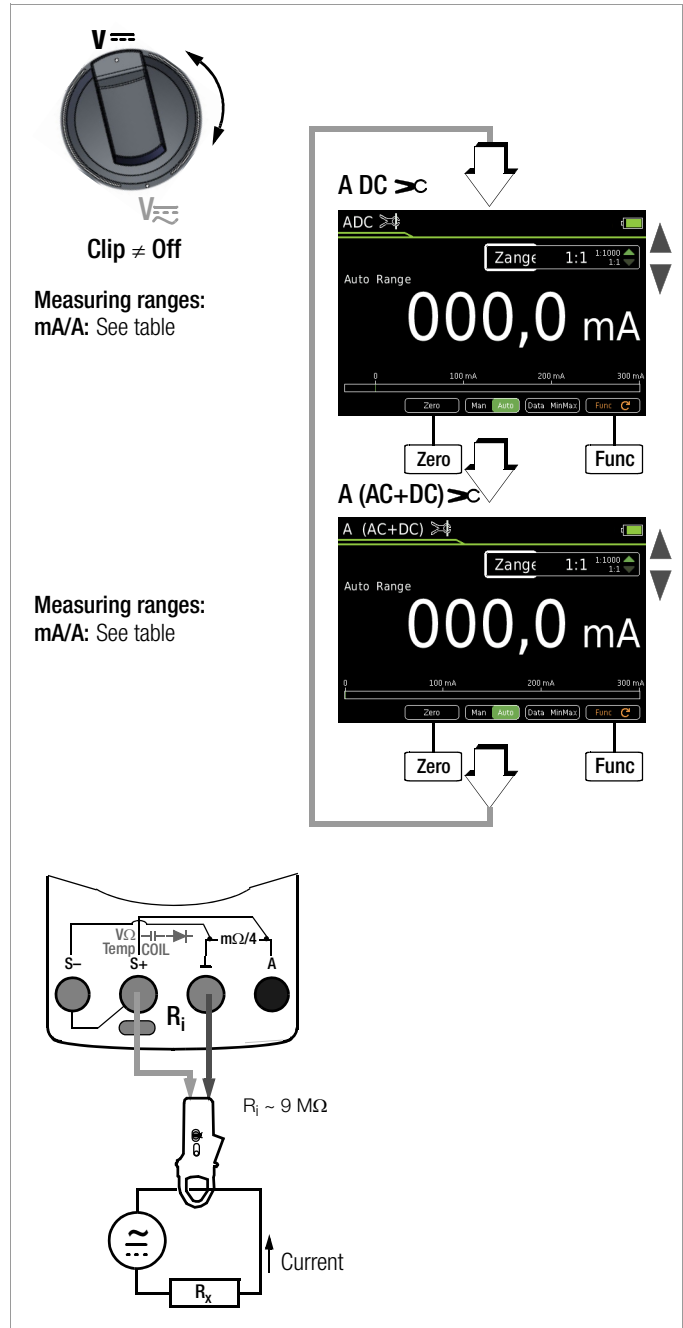

6.15.4 Alternating Current Measurement with Current Clamp Sensor – AAC and Hz

Voltage/Current Transformer Output

When a current clamp sensor is connected to the multimeter (V input), all current displays appear with the correct value in accordance with the selected transformation ratio. The only prerequisite is that the current sensor is equipped with at least one of the below listed transformation ratios, and that the ratio has been previously selected in the following menu (**Clip** ≠ **Off**).

- ⇨ Set the rotary switch to V~ or Hz.
- ⇨ Press the **MENU** key.
- ⇨ Press the “Setup for currently selected measurement” softkey.
- ⇨ Set the **Clip** parameter to the desired transformation ratio (the same ratio as selected at the current clamp sensor) as described below in the current clamp settings menu or select the desired transformation ratio with the scroll keys ▲▼.
- ⇨ The display is returned to the measurement view by pressing the **ESC** key three times.
- ⇨ Repeatedly press the **Func** softkey until the desired measuring function is displayed.
- ⇨ Connect the current clamp sensor’s measurement cables as shown.
- ⇨ If necessary, conduct zero balancing by pressing the **Zero** key (see description below).

Current Clamp Setup Menu

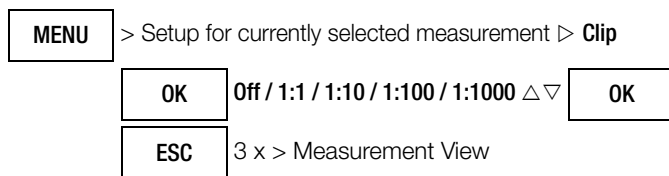

Transformation Ratio	Measuring Ranges			Clamp Type
	300 mV	3 V	30 V	
1:1 1mV/1mA	300.0 mA	3.000 A	30.00 A	METRAFLEX 300M WZ12C, Z3512A
1:10 AM 1mV/10mA	3.000 A	30.00 A	300.0 A	CP30, METRAFLEX 3000/300M WZ11B, WZ12B, Z3512A
1:100 1mV/100mA	30.00 A	300.0 A	3,000 kA	CP330/1100/1800 METRAFLEX 3000/300M, WZ11B, Z3512A
1:1000 1mV/1A	300.0 A	3,000 kA	30.00 kA	CP330/1100/1800 METRAFLEX 3000 WZ12C, Z3512A

The maximum allowable operating voltage is equal to the nominal voltage of the current transformer. When reading the measured value, additional error resulting from the current clamp sensor must also be taken into consideration (default setting: **Clip** = **Off** = voltage display).

Improving Accuracy by means of Zero Balancing – Zero

The currently measured current value can be subtracted from future measurements in all measuring ranges.

- ⇨ Press the **Zero** softkey.
- ⇨ The value ascertained for **Zero** is saved and appears above the measurement display. Automatic compensation is implemented for future measurements.

- ⇨ The correction or offset value is deleted by pressing **Zero**, by changing to another measuring function or by switching the instrument off. The value is cleared from the display.

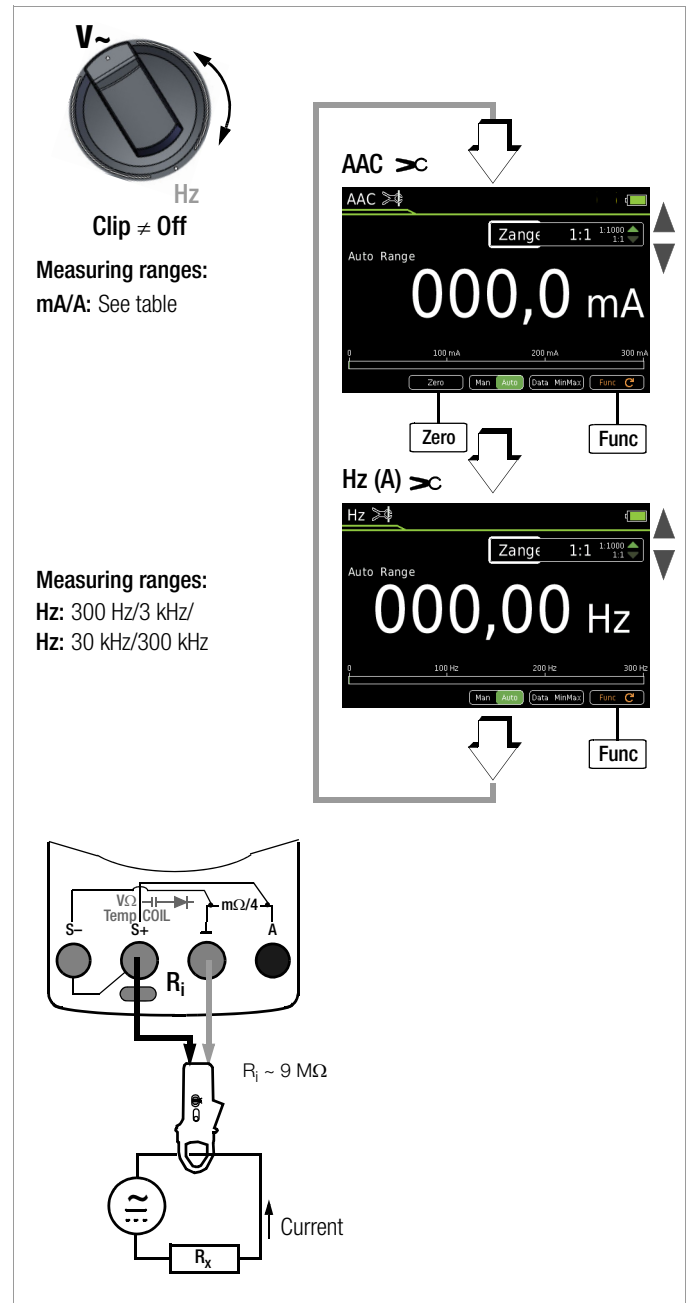

6.16 Measuring Sequences

If the same sequence of single measurements will be run frequently (one after the other with subsequent report generation), it's advisable to make use of measuring sequences.

Up to 10 measuring steps can be created for each measuring sequence. The measuring steps can include measuring functions as well as measuring instructions.

Automatic measuring sequences can be conducted in all rotary switch positions except for **OFF**.

Measuring sequences can also be created at a PC and transferred to the multimeter with the help of **IZYTRONIQ** software.

Creating a New Measuring Sequence

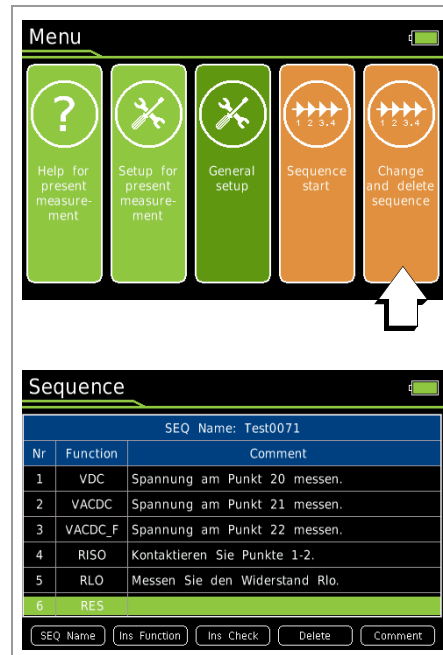

- Select any rotary switch position other than "OFF".
- Press the "MENU" key.
- Press the "Edit/delete new measuring sequence" softkey. The sequence's steps are displayed.
- First of all assign a name to the sequence to be created.
- Press the "SEQ Name" softkey to this end.
- Enter a name using the keyboard which appears at the display as described on page 10.
- Acknowledge your entry by pressing the "Enter" softkey. The sequence's steps are displayed once again.
- You can insert a measuring step with any desired measuring function after pressing the "Ins Function" softkey.
- Press the "Ins Function" key, select the desired function with the rotary switch and acknowledge your selection by pressing the **STORE** key.
- The "Information > Sequence draft > Accept function with **STORE** key" window is displayed once every 5 seconds for a duration of 1 second.
- If you would like to insert measuring instructions, press the "Ins Check" softkey.
- You can enter a comment for each measuring step (measuring function or measuring instructions), which appears at the display during the measuring sequence, for example "measure voltage at point XY". Press the "Comment" softkey to this end.
- Enter a text using the keyboard which appears at the display as described on page 10.
- Acknowledge your entry by pressing the "Enter" softkey. The sequence's steps are displayed once again.
- Individual measuring steps can be removed by selecting the desired step with the cursor and then pressing the "Delete" softkey.

Running a Measuring Sequence

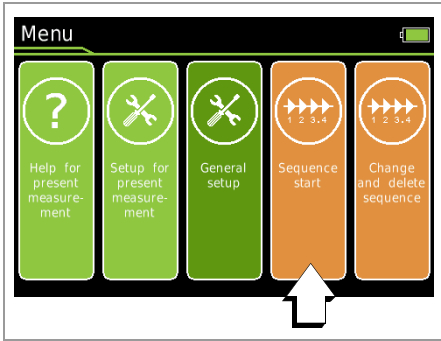

- ⇨ Select any rotary switch position other than “OFF”.
- ⇨ Press the “MENU” key.
- ⇨ Press the “Start sequence” softkey. General information concerning the measuring sequence is displayed at first:
STORE: Press the **STORE** key at the multimeter or on the Z270S probe at the end of a measuring step in order to save one or more measured values.
OK: Press the **OK** key at the end of a measuring step in order to start the next measuring step.
ESC: The sequence can be interrupted by pressing the **ESC** key. Values saved up to this point in time are stored under a name.
- ⇨ Press the “Start” softkey with red background.
- ⇨ Information concerning the pending measuring step is displayed first of all: Sequence step 1/x: Measuring function XY and measuring instructions if applicable.
- ⇨ Acknowledge this information by pressing the “OK” softkey with green background.
- ⇨ A warning appears prompting you to select the rotary switch position which is required for the respective measuring function.
- ⇨ The active sequence is displayed in the status bar by means of the **SEQ** symbol.
- ⇨ The respective measuring function is started automatically if as a voltage measurement is involved. For other measuring functions, the “Start” softkey for the respective measuring function must first be pressed, and subsequently the “Stop” softkey.
- ⇨ Press the **STORE** key in order to save the measured value
- ⇨ Press the **OK** key in order to start the next measuring step.
- ⇨ If the last measuring step of the measuring sequence is ended by pressing the “OK” softkey, the first four measuring steps or measuring functions are displayed and stored with value, date and time. Press the ▼ scroll key in order to display further measuring steps.
- ⇨ The measuring sequence is ended by pressing the “**STORE**” softkey. A corresponding message appears.

Overview of the Meanings of Softkeys and Hard Keys

Key	Meaning
Softkeys	
SEQ Name	Enter or change the name of a measuring sequence*
Ins Function	Insert a measuring step above the selected line with measuring function
Ins Check	Insert a measuring step above the selected line with measuring instructions
Delete	Delete the measuring step which was previously selected with the cursor
Comment	Enter a comment regarding the selected measuring step via the keyboard*
Start	Start the measuring sequence Start the measurement
Stop	Stop the measurement End the measuring sequence
OK	Softkey: Acknowledge instructions during the measuring sequence
Hard Keys	
▲▼	Sequence creation: Select measuring step (1 to 10)
STORE	Sequence creation: Transfer the measuring function to the sequence Sequence run: Save the measured value for the current measuring step by pressing the hard key at the multimeter or on the Z270S probe
OK	Sequence run: End the measuring step

* Description of keyboard operation for entering text (see page 10)

7 Interface Operation

7.1 Bluetooth Interface

In the case of the **METRAHIT IM XTRA BT** (M273D) and the **METRAHIT IM E-DRIVE BT** (M274B), wireless transmission is possible via Bluetooth to a PC, as well as to a smartphone or a tablet PC (Android).



Warning!

If you adjust the settings in a **METRAHIT IM XTRA BT** or **METRAHIT IM E-DRIVE BT** via Bluetooth, please make sure that the Bluetooth connection has been established with the device to be configured rather than with another METRAHIT IM device that might also be located nearby. Apart from that, we recommend using an individual device PIN in order to prevent third parties from having access to your devices.



Attention!

Any and all liability is excluded for possible software errors, in particular also resulting from interaction with other applications.

Condensed Instructions

- 1 Tap the app logo in order to start the program.
- 2 Select **METRAHIT IM XTRA BT** or **METRAHIT IM E-DRIVE BT** from the list of receivable Bluetooth devices. The following message appears: "Connecting to measuring instrument via Bluetooth".
- 3 In order to enable wireless connection, enter the same PIN which you also entered under the multimeter's PIN interface parameter. After connection has been successfully established, an analog display appears and "Measurement completed" appears at the bottom right.
- 4 You can switch back and forth amongst digital display, Y(t) measured value curve and analog display in the footer at the left-hand side.
- 5 You can start or stop a measured value recording by tapping the REC symbol.
- 6 You can switch the display to the measured value logger overview by tapping the magnifying glass icon in the footer at the right-hand side. Measuring intervals can be selected here, in order to display them graphically or transmit them.

Activating the Interface

Interface > Bluetooth > On/Off in the General Setup menu

Configuring Interface Parameters

Interface > PIN > 1234 in the General Setup menu

7.2 WiFi Interface

In the case of the **METRAHIT IM XTRA WiFi** (M273W) and the **METRAHIT IM E-DRIVE WiFi** (M274W), WiFi transmission is possible to a PC, as well as to a smartphone or a tablet PC (Android).

Activating the Interface

Interface > WiFi > On/Off in the General Setup menu

USB-Bluetooth Adapter for PC

The following Bluetooth adapters for communication between the **METRAHIT IM XTRA BT** / **METRAHIT IM E-DRIVE BT** and the PC have already been successfully tested: Belkin F8T016NG, LOGI LINK BT0007 and SITECOM CN-524 V2 001.

Bluetooth adapters from other manufacturers should meet at least the following technical requirements:

Bluetooth 4.2 + EDR, class 2

Terminal Program for a PC

Measured values received via a Bluetooth adapter can be displayed and evaluated at a terminal program.

METRALOG App for Smartphone and Tablet PC

If you use a smartphone or a tablet PC with the Android operating system and a Bluetooth interface, our **METRALOG** app provides the following functions in combination with the **METRAHIT IM XTRA BT** / **METRAHIT IM E-DRIVE BT** TRMS digital multimeter:

- Display of received multimeter measured values as: Digital or analog values, measured value curve Y(t), measured value logger
- Recording of measuring operations
- Transmission of logs via wireless services and network services
- Acoustic warning in the event that wireless connection is interrupted
- Trigger in the event of exceeding or falling short of an adjustable limit value
- SMS and/or acoustic warning in the case of trigger events

The **METRALOG** app can be obtained from the Google Play Store (see QR code to the right) and installed to your smartphone or tablet PC (operating systems as of Android 2.3.3).



8 Characteristic Values

Measuring Function (input)	Measuring Range	Resolution at Upper Range Limit		Input impedance		Intrinsic Uncertainty at Reference Conditions				Overload Capacity ²		
		30,000	3,000	≡	~ / ≙	±(... % rdg. + ... d)				Value	Time	
						30,000	3,000	30,000	30,000			
V	300 mV	10 µV		9 MΩ	9 MΩ // < 50 pF	0.15 + 10 ¹⁰				1000 V DC AC RMS Sinusoidal ⁶	Cont.	
	3 V	100 µV		9 MΩ	9 MΩ // < 50 pF	0.15 + 10			0.5 + 30			1.0 + 30
	30 V	1 mV		9 MΩ	9 MΩ // < 50 pF	0.15 + 10						
	300 V	10 mV		9 MΩ	9 MΩ // < 50 pF	0.2 + 20						
	1000 V	100 mV		9 MΩ	9 MΩ // < 50 pF	0.2 + 20						
				Voltage drop at approx. range limit			≡	~ ^{1,11}	≙ ^{1,11}			
A	300 µA	10 nA			70 mV	0.25 + 10				0.3 A	Cont.	
	3 mA	100 nA			165 mV	0.15 + 10			0.5 + 30 ¹⁰⁾			1.0 + 30 d
	30 mA	1 µA			190 mV							
	300 mA	10 µA			450 mV							
	1 A	100 µA			1.2 V							
							≡	~ ^{1,11}	≙ ^{1,11}	1 A	5 min.	
	Factor: 1:1/10/100/1000	Measuring input		Input impedance								
A >C @ V _{AC} / V _{DC}	0.3/3/30/300 A		300 mV	Voltage measurement input approx. 9 MΩ (>C V socket)		0.15 + 10 ¹⁰			0.5 + 30 d	1.0 + 30 d	Measurement input ⁶	
	3, 30, 300, 3 k A		3 V					Plus current transformer clamp error		1000 V	Max. 10 s	
				Open-circuit voltage	Meas. current at range limit	±(... % rdg. + ... d)						
						3,000						
mΩ @ 1 A pulse (4-wire)	3 mΩ		0.001 mΩ	2.8 ... 3.8 V	1 A	1.0 + 20				± 0.6 V ¹⁴	Cont.	
	30 mΩ		0.01 mΩ	2.8 ... 3.8 V	1 A	0.5 + 7						
	300 mΩ		0.1 mΩ	2.8 ... 3.8 V	1 A							
mΩ @ 200 mA (4-wire)	30 mΩ		0.01 mΩ	> 4 V	200 mA	0.5 + 7 ¹⁶				± 0.6 V ¹⁴	Cont.	
	300 mΩ		0.1 mΩ	> 4 V	200 mA							
	3 Ω		1 mΩ	> 4 V	200 mA							
mΩ @ 20 mA (4-wire)	30 Ω		10 mΩ	> 4 V	20 mA	0.5 + 7				± 0.6 V ¹⁴	Cont.	
R _L 2-wire	@ 200 mA: 3 Ω		1 mΩ	> 4 V	200 mA	2.5 + 10 ¹⁰				± 0.6 V ¹⁵	Cont.	
EN61557	@ 20 mA: 30 Ω		10 mΩ	> 4 V	20 mA	2.5 + 10 ¹⁰						
Ω (2-wire)	300 Ω	10 mΩ		< 1.4 V	Approx. 300 µA	0.2 + 30 ¹⁰				1000 V DC AC RMS Sinusoidal	Max. 10 s	
	3 kΩ	100 mΩ		< 1.4 V	Approx. 100 µA	0.15 + 10 ¹⁰						
	30 kΩ	1 Ω		< 1.4 V	Approx. 10 µA	0.15 + 10						
	300 kΩ	10 Ω		< 1.4 V	Approx. 1 µA	0.15 + 10						
	3 MΩ	100 Ω		< 1.4 V	Approx. 0.2 µA	0.5 + 10						
	30 MΩ	1 kΩ		< 1.4 V	Approx. 0.03 µA	2.0 + 10						
⊘)	300 Ω		100 mΩ	Approx. 3 V	Approx. 1 mAconst.	1 + 5 ¹⁰						
→	4,5 V ³		1 mV	Approx. 8 V		0.5 + 2						
				Discharge resistance	U ₀ max	±(... % rdg. + ... d)						
F	30 nF		10 pF	10 MΩ	0.7 V	1.5 + 10 ^{4 10}				1000 V DC AC RMS Sinusoidal	Max. 10 s	
	300 nF		100 pF	1 MΩ	0.7 V	1 + 6 ⁴						
	3 µF		1 nF	100 kΩ	0.7 V	1 + 6 ⁴						
	30 µF		10 nF	12 kΩ	0.7 V	1 + 6 ⁴						
	300 µF		100 nF	3 kΩ	0.7 V	5 + 6 ⁴						
					f _{min} ⁵	±(... % rdg. + ... d)						
Hz (V)/ Hz (A) Hz (A)	300 Hz	0.01 Hz								Hz (V) ⁶ , Hz(A)>C) ⁷ , 1000 V Hz (A): ⁷	Max. 10 s	
	3 kHz	0.1 Hz			1 Hz	0.05 + 5 ⁸						
	30 kHz	1 Hz			20 Hz							
	300 kHz	10 Hz										
			Resolution	Voltage MR ¹³	Frequency MR	±(... % MR + ... d)						
%	10.0 ... 90.0		0.1%	3 V AC	15 Hz ... 1 kHz	0.2% rdg. + 8 d			1000 V DC AC RMS Sinusoidal ⁶	Cont.		
	10.0 ... 90.0				> 1 kHz ... 4 kHz	0.2% MR/kHz + 8 d						
	5.0 ... 95.0				15 Hz ... 1 kHz	0.2% rdg. + 8 d						
	15.0 ... 85.0				> 1 kHz ... 4 kHz	0.2% MR/kHz + 8 d						
RPM	30 ... 30,000		1 RPM									
						±(... % rdg. + ... K) ⁹						
°C / °F	Pt 100	-200 ... +850 °C	0.1 °C			0.5% + 1.5			1000 V DC/AC RMS Sinusoidal	Max. 10 s		
	Pt 1000	-200 ... +850 °C				0.5% + 1.5						
	K (NiCr-Ni)	-250 ... +1372 °C				1% + 5						

¹ 15 ... 45 ... 65 Hz ... 100 kHz sinusoidal. See influence on page 48.

² At 0 ° ... + 40 °C

³ Display up to 5.1 V, "OL" for higher values.

⁴ Applies to measurements at film capacitors

⁵ Lowest measurable frequency for sinusoidal measuring signals symmetrical to the zero point

⁶ Overload capacity of the voltage measurement input:
Power limiting: frequency x voltage max. 6 x 10⁶ V x Hz @ U > 100 V

⁷ Overload capacity of the current measurement input: see current measuring ranges for maximum current values

⁸ Input sensitivity, sinusoidal signal: 10% to 100% of the voltage or current measuring range, restriction in mV measuring range: 30% rdg.
The voltage measuring ranges with max. 10 kHz apply in the A measuring range.

⁹ Plus sensor deviation

¹⁰ With active ZERO function

¹¹ Accuracy applies as of 1% MR. Values < 50 digits are suppressed at the zero point due to the TRMS transformer.

¹² 10 minute cool-down period

¹³ Required signal range: 30% to 100% of the voltage measuring range

¹⁴ The integrated FF1A/1000V fuse blows in the event of overloading

¹⁵ The integrated FF0.315A/1000V fuse blows in the event of overloading

¹⁶ For measuring range 30 mΩ and 300 mΩ with function TComp active

Key: d = digit(s), MR = measuring range, rdg. = reading (measured value)

Insulation Measurement

Measuring Range	Resolution	Nominal Voltage U_{ISO}	Intrinsic Uncertainty at Reference Conditions $\pm(\% \text{ rdg.} + d)$
3 ... 1000 V \simeq^1	1 V	Ri=1M Ω	3 + 3
300 k Ω	0.1 k Ω	50/100/250/500 V	2 + 10
3 M Ω	1 k Ω	50/100/250/500/1000 V	2 + 10
30 M Ω	10 k Ω	50/100/250/500/1000 V	2 + 10
300 M Ω	100 k Ω	50/100/250/500/1000 V	5 + 10
3000 M Ω	1 M Ω	250, 500, 1000 V	5 + 10

¹ TRMS interference voltage measurement (V_{AC+DC}) with 1 M Ω input resistance, frequency response width: > 65 Hz ... 500 Hz, accuracy: 3% + 30 digits

Measuring Function	Nom. Voltage U_N	Open-Circuit Voltage $U_{O,max.}$	Nom. Current I_N	Short-Circuit Current I_k	Acoustic Signal for	Overload Capacity Value	Overload Capacity Time
$U_{interference}/M\Omega@U_{ISO}$	—	—	—	—	$U > 1000$ V	1000 V \simeq	Continuous
$M\Omega@U_{ISO}$	50 100	1.2 x U_{INS}	1.0 mA	< 1.4 mA	$U > 1000$ V	1000 V \simeq	10 s
	250, 500 V 1000 V	1.12x U_{INS}					

Short-circuited coil test (only with optional COIL adapter)

Measuring Range	Resolution	Nominal Voltage U_{ISO}	Intrinsic Uncertainty at Reference Conditions $\pm(\% \text{ rdg.} + d)$
0.3 V ... 1000 V \simeq^1		Ri=1M Ω	3 + 30 > 100 digits
10.0 ... 30.9 μ s	0.1 [μ s]	1000 V	10 + 5 digits
31 ... 250 μ s	1 [μ s]		

¹ TRMS interference voltage measurement (V_{AC+DC}) with 1 M Ω input resistance, frequency response width: > 65 Hz ... 500 Hz, accuracy: 3% + 30 digits

Short-circuited coil test within an inductance range of: 10 μ H to 50 mH @ 100 Hz

Internal Clock

Time format DD.MM.YYYY hh:mm:ss
 Resolution 0.1 s (measured values timestamp)
 Accuracy ± 1 minute per month
 Temperature influence 50 ppm/K

Reference Conditions

Ambient temperature +23 °C ± 2 K
 Relative humidity 40% ... 75%
 Measured quantity frequency 45 Hz ... 65 Hz
 Measured quantity waveform Sinusoidal
 Supply voltage 4.0 V ± 0.1 V

Influencing Quantities and Influence Error

Influencing Quantity	Sphere of Influence	Measured Qty./ Measuring Range ¹	Influence Error ($\dots\% \text{ rdg.} + \dots d$)/10 K
Temperature	0 °C ... +21 °C and +25 °C ... +40 °C	V \simeq	0.2 + 5
		V \simeq	0.4 + 5
		300 Ω ... 3 M Ω	0.5 + 5
		30 M Ω	1 + 5
		mA/A \simeq	0.5 + 5
		mA/A \simeq	0.8 + 5
		30 nF ... 300 μ F	2 + 5
		Hz	0.2 + 5
		°C/°F (Pt100/Pt1000)	0.5 + 5

¹ With zero balancing

Frequency Influence for V_{AC} V_{AC+DC} Voltage Ranges

Frequency Range	Deviation ¹		
	300 mV range $\pm(\dots\% \text{ rdg.} + \dots \text{ digits})$	3 V, 30 V, 300 V range ² $\pm(\dots\% \text{ rdg.} + \dots \text{ digits})$	1000 V range ² $\pm(\dots\% \text{ rdg.})$
15 Hz ... 45 Hz	2 + 30	2 + 30	2 + 30
> 65 Hz ... 1 kHz	0.5 + 30	0.5 + 30	1 + 30
> 1 kHz ... 10 kHz	2 + 30	1.5 + 30	10 + 30
> 10 kHz ... 20 kHz	3 + 30	1.5 + 30	—
> 20 kHz ... 50 kHz	3 + 30	5 + 30	—
> 50 kHz ... 100 kHz	10 + 30	10 + 30	—

¹ For sinusoidal input signals > 10% to 100% of the range (mV range: as 30% of the range), at 1% to 10% of the range: f < 50 kHz, intrinsic error increased by 0.2% of the upper range limit.

² Overload capacity of the voltage measurement input:
 Power limiting: frequency x voltage max. 6×10^6 V x Hz @ $U > 100$ V

Frequency Influence for I_{AC} / I_{AC+DC} Current Measuring Ranges

Frequency Range	Influence Error ¹	
	300 μ A to 300 mA $\pm(\dots\% \text{ rdg.} + \dots \text{ digits})$	1 A range $\pm(\dots\% \text{ rdg.} + \dots \text{ digits})$
15 Hz ... 45 Hz	2 + 30	2 + 30
> 65 Hz ... 1 kHz	1 + 30	1 + 30
> 1 kHz ... 2 kHz	1 + 30	1 + 30
> 2 kHz ... 5kHz	1 + 30	3 + 30
> 5 kHz ... 10 kHz	5 + 30	5 + 30

¹ For sinusoidal input signals > 10% to 100% of the range.

Influencing Quantity	Sphere of Influence	Measured Qty./ Measuring Range	Influence Error ¹
Crest Factor CF	1 ... 3	V \sim , A \sim	$\pm 1\% \text{ rdg.}$
	> 3 ... 5		$\pm 3\% \text{ rdg.}$

¹ Except for sinusoidal waveform

Influencing Quantity	Sphere of Influence	Measured Qty.	Influence Error
Relative Atmospheric Humidity	75% 3 days instrument off	V, A, Ω , F, Hz, °C	1 x intrinsic uncertainty
Battery Voltage	3.6 ... 4.2 V	Ditto	Included in intrinsic uncertainty

Influencing Quantity	Sphere of Influence	Measured Qty./ Measuring Range	Damping
Common Mode Interference Voltage	Interference quantity max. 1000 V \sim 50 Hz ... 60 Hz sinusoidal	V \simeq	> 90 dB
		3 V \sim ,	> 90 dB
		30, 300 V \sim	> 150 dB
Series Mode Interference Voltage	Interference quantity: V \sim , respective nominal value of the measuring range, max. 1000 V \sim , 50 Hz ... 60 Hz sinusoidal	V \simeq	> 50 dB
		V \sim	> 50 dB

Response Time (after manual range selection)

Measured Qty./ Measuring Range	Response Time Digital Display	Jump Function of the Measured Quantity
V \simeq , V \sim A \simeq , A \sim	1.5 s	From 0 to 80% of upper range limit value
300 Ω ... 3 M Ω	2 s	
30 M Ω , M $\Omega@U_{ISO}$	Max. 5 s	
Continuity	< 50 ms	
°C (Pt 100)	Max. 3 s	From ∞ to 50% of upper range limit value
\rightarrow	1.5 s	
30 nF ... 300 μ F	Max. 5 s	From 0 to 50% of upper range limit value
>10 Hz	1.5 s	

Display

TFT color graphic display (55 x 36 mm) with analog and digital display including unit of measure, type of current and various special functions

Background Illumination

Activated background illumination can be regulated by means of a light sensor.

Analog Bar Graph

Scaling Linear
Polarity display With automatic switching
Sampling rate 40 measurements per second and display refresh

Digital Measured Value Display

Resolution / char. height 320 x 480 dots, 12 mm
Number of places 31,000 / 3,100
4 $\frac{3}{4}$ -place in the V, A, Hz and Ω , measuring functions depending on parameter setting
Overflow display "OL" is displayed for $\geq 31,000$ digits or ≥ 3100 digits
Polarity display "-" (minus sign) is displayed if plus pole is connected to "1"
Sampling rate 10 and 40 measurements per second with the Min-Max function except for the capacitance, frequency and duty cycle measuring functions
Refresh rate 2 times per second, every 500 ms

Electrical Safety

Protection category II per EN 61010-1:2010/VDE 0411-1:2011
Measuring category CAT III CAT IV
Nominal voltage 1000 V 600 V
Pollution degree 2
Test voltage 7.4 kV~ per EN 61010-1:2011/VDE 0411-1:2011

Fuse

Current measuring ranges & 2L m Ω measuring ranges **F1:** FF 1 A/1000 V AC/DC; 6.3 x 32 mm
Fuse with breaking capacity of 30 kA at 1000 V AC/DC, protects the current measurement input in the 300 μ A to 1 A ranges
2L m Ω measuring ranges **F2:** FF 0,315 A / 1000 V 6.3 x 32 mm
Fuse with breaking capacity of 30 kA at 1000 V AC/DC

Power Supply

Battery pack 3.7 V, 4000 mAh, LiPo (approx. 25% self-discharging per year)
Service life Approx. 20 hours (without M Ω _{INS} measurement / R_{LO} / R 4-wire)
Battery indicator Battery capacity display via battery symbol: , querying of momentary charge level via menu function.
Power OFF function The multimeter is switched off automatically:
– When battery voltage drops to below approx. 3.6 V
– If none of the keys or the rotary switch are activated for an adjustable duration of 10 to 59 min. and the multimeter is not in the continuous operation mode

Rechargeable battery packs can only be recharged externally.

Measuring Function	Nominal Voltage U _N	DUT Resistance	Service Life in Hours	Number of Possible Measurements with Nom. Current per VDE 0413
V \equiv			20 ¹	
V \sim			15 ¹	
RISO	100 V	1 M Ω	5	
	100 V	100 k Ω		300
	500 V	500 k Ω		60
	1000 V	2 M Ω		20

¹ Times 0.7 for interface operation

Electromagnetic Compatibility (EMC)

Interference emission EN 61326-1:2013 class B

Interference immunity EN 61326-1:2013
Short-term measured value deviation of up to 10% may occur during electromagnetic interference thus reducing the specified operating quality.

Ambient Conditions

Accuracy range 0 °C ... +40 °C
Operating temperatures (storage temp. w. battery) 10 °C ... +50 °C
–20 °C ... +50 °C with rubber holster
Storage temperatures –25 °C ... +70 °C (without battery)
Relative humidity 40 ... 75%, no condensation allowed
Elevation To 2000 m
Place of use Indoors, except within specified ambient conditions

Data Interface

Type	Bluetooth 4.2
Frequency band	2.402 ... 2.480 GHz
Transmitting power	Max. 91 mW
Functions	– Query measuring functions and parameters – Query momentary measurement data

Internal Measured Value Storage

Memory capacity	64 MBit for approx. 300,000 measured values with indication of date and time
-----------------	--

Mechanical Design

Housing	Impact resistant plastic (ABS)
Dimensions	235 x 105 x 56 mm (without rubber holster)
Weight	Approx. 0.7 kg with battery pack
Protection	Housing: IP 52 (pressure equalization by means of the housing)

Table Excerpt Regarding Significance of IP Codes

IP XY (1 st digit X)	Protection Against Foreign Object Ingress	IP XY (2 nd digit Y)	Protection Against Water Ingress
0	Not protected	0	Not protected
1	≥ 50.0 mm Ø	1	Vertically falling droplets
2	≥ 12.5 mm Ø	2	Dripping (15° angle)
3	≥ 2.5 mm Ø	3	Spraying water
4	≥ 1.0 mm Ø	4	Splashing water
5	Dust protected	5	Jet-water

Applicable Regulations and Standards

IEC 61010-1 DIN EN 61010-1 VDE 0411-1	Safety requirements for electrical equipment for measurement, control and laboratory use – Part 1: General requirements
DIN EN 61326-1 VDE 0843-20-1	Electrical equipment for measurement, control and laboratory use –EMC requirements – Part 1: General requirements
DIN EN 60529 VDE 0470-1	Test instruments and test procedures – degrees of protection provided by enclosures (IP code)

9 Maintenance and Calibration



Note

Recommendation:

Disconnect the instrument from the measuring circuit before removing the battery pack or the mains module!



Attention!

Disconnect the instrument from the measuring circuit before opening the fuse cover in order to replace the fuse!

9.1 Displays – Error Messages

Message	Function	Meaning
FUSE	Current measurement	Blown fuse
	In all operating modes	Battery voltage has fallen below 3.3 V
OL	Measurement	Indicates overflow

9.2 Battery Pack



Note

Removing the Battery Pack during Periods of Non-Use

The integrated quartz movement draws power from the battery pack even when the instrument is switched off. It's advisable to remove the battery pack before long periods of non-use for this reason (e.g. vacation). This prevents excessive depletion, which may result in damage to the lithium-ion batteries under unfavorable conditions.



Note

Removing the Battery Pack or Mains Module

Stored measurement data are not lost when the battery pack or the mains module is removed. The selected operating parameters remain in memory, although date and time must be reentered.

End any automatic measured data recordings which are currently running before removal. Removing the battery pack or the mains module during storage operations may cause data loss or corrupt memory.

Querying the Battery Pack's Charge Level

Momentary battery capacity can be queried by clicking the **Info** item in the **General Setup** menu:

- ⇨ Press the **MENU** key to this end.
- ⇨ Then press the **General Setup** softkey.
- ⇨ Select the **Info** parameter with the help of the Δ/∇ scroll keys. The "Battery" parameter indicates the battery pack's charge level as a percentage.



Attention!

Disconnect the instrument from the measuring circuit before removing the battery pack for charging!

If the "

Removing the Battery Pack



Note

Recommendation:

Turn the rotary switch to the **OFF** position and disconnect the instrument from the measuring circuit before removing the battery pack or the mains module!

- ⇨ Briefly press the two locking tabs towards each other at the same time with thumb and forefinger, and then release them again. Pull the battery pack up and out as shown in the figure to the right.

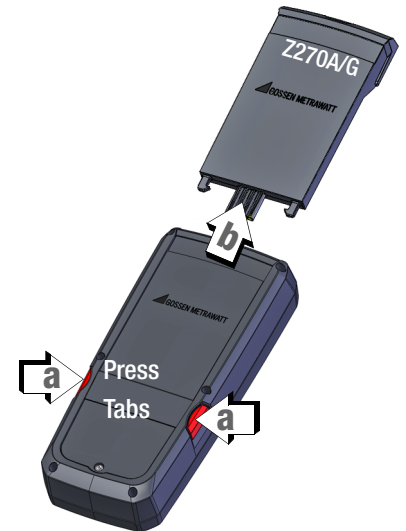

Charging the Battery Pack

- ⇨ Connect the micro USB port to the charger.

The charge LED lights up yellow during the charging process. The charging cable can be removed as soon as the charge LED lights up green at the end of the charging process.

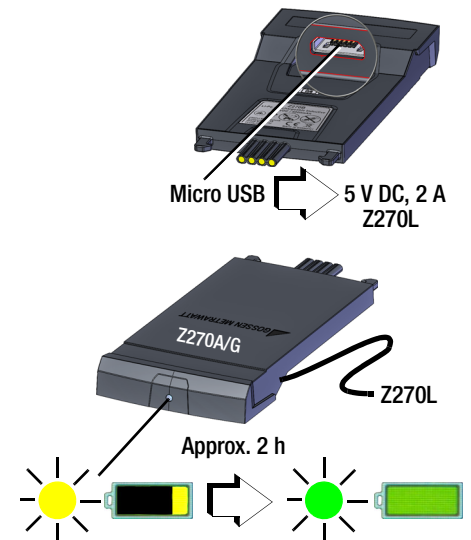

Attention!

Please observe the currently valid safety notes for lithium-ion batteries!

Installing the Battery Pack

- ⇨ Push the battery pack back in until resistance is plainly perceptible.
- ⇨ In order to snap the battery back into place, press the two locking tabs towards each other at the same time with thumb and forefinger.
- ⇨ Push the battery back into its final position and release the locking tabs.

9.3 Fuse

Testing the Fuse

The fuse is tested automatically:

- When the instrument is switched on with the rotary switch in the A position
- When the instrument is already on and the rotary switch is turned to the A position
- In the active current measuring range when voltage is applied

If the fuse is blown or if no fuse has been inserted the "FUSE" symbol appears at the display. The fuse interrupts the current measuring ranges. All other measuring ranges remain functional.

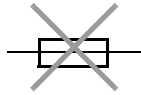

Replacing the Fuse

If a fuse should blow, eliminate the cause of overload before placing the instrument back into service!



Attention!

Disconnect the instrument from the measuring circuit before opening the fuse cover in order to replace the fuse!

- ⇨ Set the instrument face down onto the working surface.
- ⇨ Turn the slotted screw on the cover with the fuse symbol counter-clockwise.
- ⇨ Lift off the cover and pry the fuse out using the flat side of the fuse cover.
- ⇨ Insert a new fuse. Make sure that the fuse is centered, i.e. between the tabs at the sides.
- ⇨ When replacing the fuse cover, insert the side with the guide hooks first. Tighten the screw by turning it clockwise.
- ⇨ Dispose of the blown fuse with the trash.



Attention!

Use specified fuses only!
If fuses with other blowing characteristics, other current ratings or other breaking capacities are used, the operator is placed in danger, and protective diodes, resistors and other components may be damaged.
The use of repaired fuses or short-circuiting the fuse holder is prohibited.



Note

Testing the Fuse with the Instrument Switched On

After inserting the fuse with the instrument switched on, the instrument must be switched off briefly and then switched back on again, or briefly switched to a non-current measuring range and then back to the A measuring range.

If contact is poor or the fuse is blown, the "FUSE" symbol appears at the display.

9.4 Housing Maintenance

No special maintenance is required for the housing. Keep outside surfaces clean. Use a slightly dampened cloth for cleaning. In particular for the protective rubber surfaces, we recommend a moist, lint-free microfiber cloth. Avoid the use of cleansers, abrasives or solvents.

9.5 Measurement Cables

Inspect the measurement cables for mechanical damage at regular intervals.



Attention!

Even in the case of minimal damage to the test leads, we recommend sending them to GMC-I Service GmbH without delay.

9.6 Returns and Environmentally Sound Disposal

The instrument is a category 9 product (monitoring and control instrument) in accordance with ElektroG (German electrical and electronic device law). This device is subject to the RoHS directive. Furthermore, we make reference to the fact that the current status in this regard can be accessed on the Internet at www.gossenmetrawatt.com by entering the search term WEEE.

We identify our electrical and electronic devices in accordance with WEEE 2012/19/EU and ElektroG using the symbol shown at the right per DIN EN 50419.



These devices may not be disposed of with the trash.

Please contact our service department regarding the return of old devices (see address in Chapter 1.3).

Disposal of the Battery Pack (rechargeable lithium-ion battery)

If the battery pack is no longer usable, it must be disposed of properly in accordance with valid national directives.

Dispose of the rechargeable battery in accordance with applicable regulations or send it to GMC-I Service GmbH for free disposal (see address in Chapter 1.3).

9.7 Recalibration

The measuring tasks performed with your instrument, and the stressing it's subjected to, influence aging of its components and may result in deviation from the specified levels of accuracy.

In the case of strict measuring accuracy requirements, as well as in the event of use at construction sites with frequent stress due to transport and considerable temperature fluctuation, we recommend a relatively short calibration interval of once per year. If your instrument is used primarily in the laboratory and indoors without considerable climatic or mechanical stressing, a calibration interval of once every 2 to 3 years is sufficient as a rule.

During recalibration* at an accredited calibration laboratory (DIN EN ISO/IEC 17025), deviations from traceable standards demonstrated by your measuring instrument are documented. Ascertained deviations are used to correct display values during later use of the instrument.

We would be happy to perform DAkkS or factory calibration for you at our calibration laboratory. Further information is available on our website:

www.gossenmetrawatt.com (→ COMPANY → Quality and Certificates → DAKKS Calibration Center → Calibration Questions and Answers.

Recalibration of your instrument at regular intervals is essential for the fulfillment of requirements according to quality management systems per DIN EN ISO 9001.



Note

Regular calibration of the test instrument should be performed in a calibration laboratory which is accredited per DIN EN ISO/IEC 17025.

* Examination of the specification, as well as adjustment, are not included in calibration. However, in the case of our own products, any required adjustment is performed and adherence to the specification is confirmed.

9.8 Manufacturer's Guarantee

All **METRA HIT** digital multimeters and calibration instruments are guaranteed for a period of 3 years after date of shipment. The manufacturer's guarantee covers materials and workmanship. Damages resulting from use for any other than the intended purpose or operating errors, as well as any and all consequential damages, are excluded.

The calibration certificate confirms that the product's specified technical data were complied with at the point in time of calibration. We guarantee compliance with the specified technical data within the permissible tolerances for a period of 12 months after delivery.

10 Accessories

10.1 General

The extensive accessories available for our measuring instruments are checked for compliance with currently valid safety regulations at regular intervals, and are expanded as required for new applications. Currently up-to-date accessories which are suitable for your measuring instrument are listed at the following web address along with photo, order number, description and, depending upon the scope of the respective accessory, data sheet and operating instructions: www.gossenmetrawatt.de (→ **PRODUCTS** → Measuring Technology – Portable – Multimeters → Specialized Applications → **METRAHIT IM XTRA** ... → Accessories).

10.2 Technical Data for Measurement Cables (included with KS17-2 cable set and Z270S probe)

Electrical Safety

Maximum rated voltage	600 V	1000 V	1000 V
Measuring category	CAT IV	CAT III	CAT II
Maximum rated current	1 A	1 A	16 A
With safety cap attached	•	•	—
Without safety cap	—	—	•

Observe the measuring instrument's maximum values for electrical safety!

Ambient Conditions (EN 61010-031)

Temperature	-20 °C ... + 50 °C
Relative humidity	50 ... 80%
Pollution degree	2

Use of KS17-2 and Z270S



Attention!

Measurements per DIN EN 61010-031 may only be performed in environments in accordance with measuring category III with the safety cap attached to the test probe at the end of the measurement cable.

In order to establish contact inside 4 mm jacks, the safety caps have to be removed by prying open the snap fastener with a pointed object (e.g. the other test probe).

11 Index

A	
Absorption Index Measurement	25
Accessories	2, 53
Addresses	4
Automatic Shutdown	
Specifying a Time	11
AUTO-Range Function	13
B	
Battery Pack	
Charge Level Symbols at the Display	7
Charging	51
Disposal	52
Installation	51
Periods of Non-Use	51
Querying Charge Level via Menu	51
Removal	51
Bluetooth	46
C	
Cable Resistance	33
Calibration Seal	8
Capacitance Measurement	32
Continuity Test	35
Current Clamp Sensor	42, 43
Current Measurement	
Notes	39
D	
Data Backup	6
Device Returns	52
Diode Test	35
Discharge	21
Discharging	24
Duty Cycle Measurement	29
E	
Error	21
Error Messages	51
F	
Fuse	
Replacement	52
Test	52
G	
Guarantee	53
I	
Included Features	2
Interface	
Bluetooth	46
WiFi	46
Interference Voltage Detection	21
K	
Keyboard for Entering Text	10
M	
Maintenance	
Housing	52
Manufacturer's Guarantee	53
Measured Value Storage	
Data Function	15
Min-Max Values	16
Measurement Cables	53
Measuring Category	
Significance	5
Measuring Range Selection	
Automatic	13
Manual	13
Memory	
Activating the Trigger	18
Adjusting Recording Time	17
Clearing Memory	19
Creating Groups	19
Ending Recording	19
Querying Occupancy	19
Setting Hysteresis	18
Setting the Recording Type	17
Setting the Sampling Rate	17
Start Recording	19
Trigger Mode Operation	18
MemoryAdjusting the Trigger Threshold	18
Milliohm Measurement	
2-Wire Measurement	36
4-Wire Measurement	37
O	
Overview	
Keys and Connections	7
P	
Parameter	
Adjusting Recording Time	17
Auto-OFF	11
Brightness	9
Change Password	10
Clear Memory	19
Date/Time	9
Default Settings	11
Display Profile	10
Display Zeros	10
Entering the Reference Temperature	34
Language	9
Manual/Measured Reference Temperature	34
Measured Reference Temperature	34
Query Memory Occupancy	19
Setting the Sampling Period	17
Temperature U/M	34
Password	
Change	10
Parameter Changes	20
Polarization Index Measurement	26
Product Support	4
Product Support Hotline	4
R	
Recalibration	53
Recalibration Service	4, 53
Reference Junction	34
Repair and Replacement Parts Service	4
Resistance Measurement	31
Returns	
Device	52
RPM Measurement	29
S	
Safety Precautions	5
Battery Pack	6
General	5
Scope of Delivery	2
Short-Circuited Coil Measurement	22
Switching the Instrument On	
Manual	9
Symbols	
Danger	6
Digital Display	7
Instrument	8
on the Instrument	8
Rotary Switch Positions	8
User Interface	8

T	
Temperature Measurement	
With Thermocouples	34
Test Sequences	44
U	
Use for Intended Purpose	5
Use of KS17-2 and Z270S	53
V	
Voltage Comparator	28, 29, 30
Voltage Measurement	
Notes	27
W	
WEEE Mark	8

Edited in Germany • Subject to change without notice • PDF version available on the Internet

 **GOSSEN METRAWATT**

GMC-I Messtechnik GmbH
Südwestpark 15
90449 Nürnberg • Germany

Phone: +49-911-8602-111
Fax: +49 911 8602-777
E-mail info@gossenmetrawatt.com
www.gossenmetrawatt.com